

 PTM27

High-precision inclination sensor
with robust, compact plastic housing



- **Measurement range up to $\pm 180^\circ$**
- **Resolution up to 0.001°**
- **Protection class IP67**
- **Longitudinal water barrier; potted electronics**
- **Wear-free MEMS technology, shock resistant**

Product versions



Analog output



Digital output CAN



PTM27 - Inclination sensor in MEMS technology
Version with analog output

Specifications

			Order options
Number and orientation of inclination axes	Inclination in X axis, orientation 1A Inclination in X axis, orientation 1B Inclination in X axis, orientation 1C Inclination in X and Y axes, orientation 2A Inclination in X and Y axes, orientation 2B Inclination in X and Y axes, orientation 2C	1	1A 1B 1C 2A 2B 2C
Measurement range	±5 ... 180° (selectable in 5° increments)	2	5 ... 180
Output	Voltage 0.5 ... 4.5 V (U _B = 24 V) Voltage 0.5 ... 10 V (on request) Voltage 0.5 ... 4.5 V (U _B = 5 V) (on request) Current 4 ... 20 mA, 3 wire (on request)	3	U8 U2 (on request) U6 (on request) I1 (on request)
Signal characteristics	Increasing signal for CW inclination Increasing signal for CCW inclination	4	CW CCW
Resolution	0.005° (measurement range ±180°) 0.001° (measurement range ±5°)		
Linearity	±0.05° (up to ±30°) ±0.1° (up to ±60°) ±0.2° (up to ±180°)		
Housing material	Plastic		
Mounting	Screws M4: DIN 912, DIN 6912, DIN 7984		
Protection class	IP67		
Output delay	0.1 s ... 10 s / 90%	5	T0.1 ... T10.0
Connection	Cable, standard length 2 m	6	KAB2M
Shock	DIN EN 60068-2-27:2010, 100 g/11 ms, 100 shocks		
Vibration	DIN EN 60068-2-6:2008, 20 g 10 Hz-2 kHz, 10 cycles		
Temperature range	-40° ... +85°C		
Weight	approx. 20 g (without cable)		
EMC	DIN EN 61326-1:2013		

Order code

PTM27	-	1	-	2	-	3	-	4	-	5	-	6
-------	---	----------	---	----------	---	----------	---	----------	---	----------	---	----------

Order example: PTM27 – 1A – 180 – U8 – CW – T1.0 – KAB2M



PTM27 - Inclination sensor in MEMS technology
Version with digital output CAN

Specifications

		Order options
Output	CANopen SAE J1939	1 CANOP CANJ1939
Measurement range	±180°	
Resolution	0.001°	
Linearity	±0.05° (up to ±30°) ±0.1° (up to ±60°) ±0.2° (up to ±180°)	
Housing material	Plastic	
Mounting	Screws M4: DIN 912, DIN 6912, DIN 7984	
Protection class	IP67	
Output delay	0.1 s ... 10 s / 90%, configurable	
Connection	Cable 0.3 m with connector M12, 5 pin	2 KAB0,3M – M12/CAN
Shock	DIN EN 60068-2-27:2010, 100 g/11 ms, 100 shocks	
Vibration	DIN EN 60068-2-6:2008, 20 g 10 Hz-2 kHz, 10 cycles	
Temperature range	-40° ... +85°C	
Weight	approx. 20 g (without cable)	
EMC	DIN EN 61326-1:2013	

Order code

PTM27 – **1** – **2**

Order example: PTM27 – CANOP – KAB0,3M – M12/CAN

Dimensions

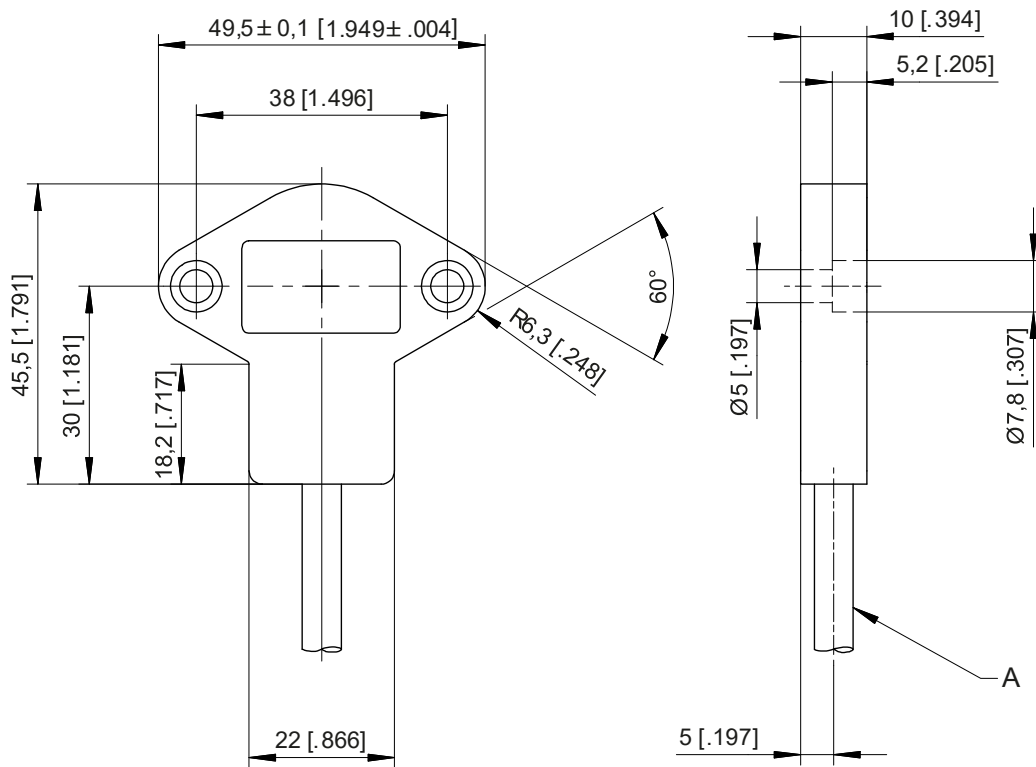

A – Cable

Dimensions in mm [inch].

Dimensions informative only.

For guaranteed dimensions consult factory.

Output specification

Analog output

U8 Voltage output 0.5 ... 4,5 V 	Excitation voltage	8 ... 36 V DC
	Excitation current	typical 12 mA max. 16 mA
	Output voltage	0.5 ... 4,5 V DC
	Output current	2 mA max.
	Measuring rate	1 kHz standard
	Stability (temperature)	$\pm 50 \times 10^{-6}$ / °C f.s. (typical)
	Protection	Reverse polarity, short circuit
	Operating temperature	-40 ... +85 °C
	EMC	DIN EN 61326-1:2013

U2 Voltage output 0.5 ... 10 V 	Excitation voltage	8 ... 36 V DC
	Excitation current	typical 12 mA max. 16 mA
	Output voltage	0.5 ... 10 V DC
	Output current	2 mA max.
	Measuring rate	1 kHz standard
	Stability (temperature)	$\pm 50 \times 10^{-6}$ / °C f.s. (typical)
	Protection	Reverse polarity, short circuit
	Operating temperature	-40 ... +85 °C
	EMC	DIN EN 61326-1:2013

U6 Voltage output 0.5 ... 4.5 V 	Excitation voltage	5 V DC ± 10 %
	Excitation current	typical 13 mA max. 16 mA
	Output voltage	10 ... 90 % of the excitation voltage
	Output current	2 mA max.
	Measuring rate	1 kHz standard
	Stability (temperature)	$\pm 50 \times 10^{-6}$ / °C f.s. (typical)
	Protection	Reverse polarity, short circuit
	Operating temperature	-40 ... +85 °C
	EMC	DIN EN 61326-1:2013

I1 Current output 4 ... 20 mA, 3 wires 	Excitation voltage	8 ... 36 V DC
	Excitation current	typical 32 mA max. 36 mA
	Load R _L	500 Ω max.
	Output current	4 ... 20 mA
	Measuring rate	1 kHz standard
	Stability (temperature)	±50 x 10 ⁻⁶ / °C f.s. (typical)
	Protection	Reverse polarity, short circuit
	Operating temperature	-40 ... +85 °C
	EMC	DIN EN 61326-1:2013

Signal wiring	Output signals	Cable color
1 axis	+U _B (excitation voltage)	brown
	Output X	white
	GND	blue
	Do not connect!	grey

Signal wiring	Output signals	Cable color
2 axes	+U _B (excitation voltage)	brown
	Output X	white
	GND	blue
	OUTPUT Y	black
	Do not connect!	grey

Digital output CANopen

CANOP CANopen 	Communication profile	CANopen CiA 301, Slave
	Encoder profile	CiA 410, Profile „Inclinometer“
	Configuration services	LSS, CiA Draft Standard 305 (Transmission rate, node ID)
	Error Control	Node guarding, Heartbeat, Emergency message
	Node ID	Adjustable via LSS or SDO, default: 127
	PDO	1 TxPDO, 0 RxPDO, no linking, static mapping
	PDO Modes	Event-/Time triggered, Remote-request, Sync cyclic/acyclic
	SDO	1 Server, 0 Client
	Certified	yes
	Transmission rate	125 kBit ... 1 Mbit, adjustable via LSS or SDO, default: 125 kBit
	Bus connection	M12 connector, 5 pin
	Bus, galvanic isolated	no
	Error Control Baudrate	50 kBit/s ... 1 MBit/s configurable
	Transceiver	24V-compliant, not isolated
	Internal termination resistor	120 Ohm configurable

Specifications	Excitation voltage	8 ... 36 V DC
	Excitation current	15 mA typical at 24 V DC 30 mA typical at 12 V DC 100 mA max.
	Measuring rate	0.5 kHz standard
	Stability (temperature)	± 0,2° (-20 ... +40 °C) ± 0,4° (-40 ... +85 °C)
	Repeatability	1 LSB
	Operating temperature	-40 ... +85 °C
	Protection	Reverse polarity, short circuit
	EMC	DIN EN 61326-1:2013

Signal wiring	Output signals	Connector pin no.
Connector M12, 5 pin  View to the sensor connector	Shield	1
	Excitation +	2
	GND	3
	CAN-H	4
	CAN-L	5

Digital output SAE J1939

CANJ1939 SAE J1939 	CAN Specification	ISO 11898, Basic and Full CAN 2.0 B extended message format with 29-bit identifier
	Transceiver	24V-compliant, not isolated
	Communication profile	SAE J1939, 29-bit identifier
	Transmission rate	250 kBit/s
	Internal termination resistor	120 Ω
	Address	Default 247d, configurable

NAME - Unique device identifier	Name Fields	Remark	Field value	Size [Bit]	Byte order	Byte value
	Arbitrary Address Capable	No	0	1	Byte 8 (MSB)	00h
	Industry Group	Global	0	3		
	Vehicle System instance		0	4		
	Vehicle System	Non specific	7Fh	7	Byte 7	FEh
	Reserved		0	1		
	Function	Non specific	FFh	8	Byte 6	FFh
	Function Instance		0	5	Byte 5	00
	ECU Instance		0	3		
	Manufacturer	Manufacturer Code	145h	11	Byte 4	28h
						Byte 3
		Identity Number	n..nh	21		
						Byte 2
					Byte 1	nnh

Proprietary PGN - Manufacturer specific Parameter Group Numbers	Configuration data	PGN EFddh	Proprietary-A (PDU1 peer-to-peer)
	Process data	PGN FFnnh	Proprietary-B (PDU2 broadcast); nn Group Extension (PS) configurable

Specifications		
	Excitation voltage	8 ... 36 V DC
	Excitation current	15 mA typical at 24 V DC 30 mA typical at 12 V DC, 100 mA max.
	Measuring rate	0.5 kHz (asynchronous)
	Stability (temperature)	± 0,2° (-20 ... +40 °C) ± 0,4° (-40 ... +85 °C)
	Repeatability	1 LSB
	Operating temperature	-40 ... +85 °C
	Protection	Reverse polarity, short circuit
	EMV	DIN EN 61326-1:2013

Signal wiring	Output signals	Connector pin no.
Connector M12, 5 pin  View to the sensor connector	Shield	1
	Excitation +	2
	GND	3
	CAN-H	4
	CAN-L	5

PTM27 - Characteristic of the linear output and axis orientation

Sensor position as shown equals 0°.

1 Measuring axis

Axis orientation
1A

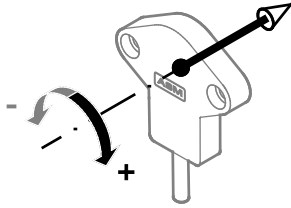

Axis orientation
1B

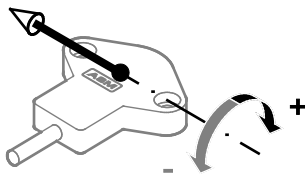

Axis orientation
1C

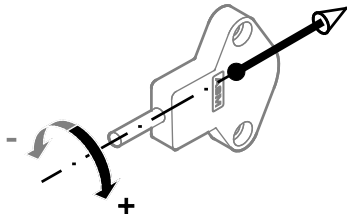

2 Measuring axes

Axis orientation
2A

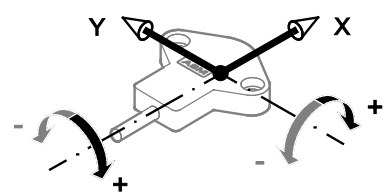

Axis orientation
2B

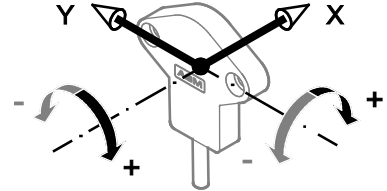

Axis orientation
2C

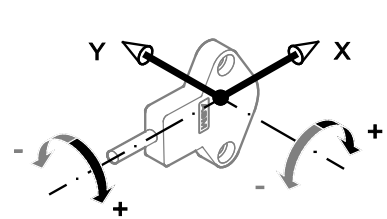

Output signal

