



perfect in sensors.

# POSIWIRE®

Cable Extension Position Sensors

**WS12EX**  
**Position Sensor**

Datasheet



### **Copyright**

© ASM GmbH  
Am Bleichbach 18-24  
85452 Moosinning  
Germany

The information presented in this data sheet does not form part of any quotation or contract, is believed to be accurate and reliable and may be changed without notice. No liability will be accepted by ASM for any consequence of its use. Publication thereof does not convey nor imply any license under patent or industrial or intellectual property rights. Applications that are described herein for any of these products are for illustrative purpose only.

ASM makes no representation or warranty that such applications will be suitable for the specified use without further testing or modification.

---

<b>Analog output, Dust Explosion-Proof .....</b>	<b>4</b>
Specifications .....	4
Order code .....	5
<b>Output specifications .....</b>	<b>8</b>
Analog outputs .....	8
Voltage divider R1K .....	8
Signal conditioner 10V .....	9
Signal conditioner 420A .....	10
Signal conditioner 420T .....	11

## Analog output, Dust Explosion-Proof

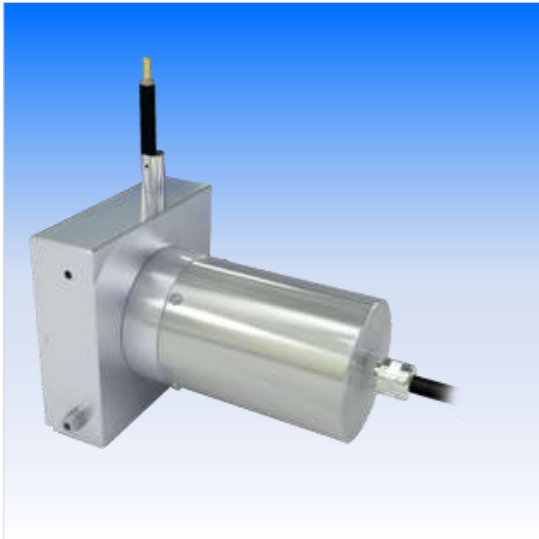

### Sensor features

- Measurement range up to 3000 mm
- Analog output
- DIN EN 60079-0 (June 2014)  
DIN EN 60079-31 (December 2014)

-  II 3D Ex tc III C T80°C Dc

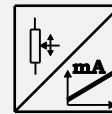
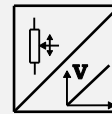
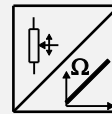

### Specifications

<b>Output</b>	<b>R1K</b> = Potentiometer 1 kΩ <b>10V</b> = Voltage 0 ... 10 V <b>420A</b> = Current 4 ... 20 mA, 2 wire <b>420T</b> = Current 4 ... 20 mA, 3 wire Excitation voltage WS-EX sensors: typ. 24 V DC
<b>Resolution</b>	Quasi infinite
<b>Linearity</b>	±0.10% f.s. (standard) ±0.05% f.s. (optional)
<b>Sensing device</b>	Precision potentiometer
<b>Housing material</b>	Aluminium measuring cable: stainless steel
<b>Protection class of the housing</b>	IP65
<b>Connection</b>	Cable output, standard length 2 m
<b>Weight</b>	Up to 1500 mm approx. 1 kg, from 2000 mm approx. 1.5 kg
<b>Temperature range</b>	-20°C ... + 40°C
<b>Standards</b>	
<b>Dust-Ex Proof</b>	DIN EN 60079-0 (June 2014) DIN EN 60079-31 (December 2014)
<b>EMC</b>	DIN EN 61326-1:2013
<b>Shock</b>	DIN EN 60068-2-27:2010, 50 g 11 ms, 100 shocks
<b>Vibration</b>	DIN EN 60068-2-6:2008, 20 g 10 Hz-2 kHz, 10 cycles

**Order code****WS12EX** – 1 – 2 – 3 – 4 – 5**1 Measurement range (in mm)**

100 / 125 / 500 / 1000 / 1250 / 1500 / 2000 / 2500 / 3000

**2 Output**

**R1K** = Potentiometer 1 kΩ  
**10V** = Voltage 0 ... 10 V  
**420A** = Current 4 ... 20 mA, 2 wire  
**420T** = Current 4 ... 20 mA, 3 wire  
Excitation voltage WS-EX sensors: typ. 24 V DC

**3 Linearity**

**L10** = ±0.10% f.s. (standard)  
**L05** = ±0.05% f.s. (optional)

**4 Cable fixing**

**M4** = M4 cable fixing  
**SB0** = cable clip

**5 Connection****KAB2M** = Cable output, standard length 2 m**Order example****WS12EX – 3000 – 10V – L10 – M4 – KAB2M**

Cable forces typical at = 20 °C	Measurement range	Maximum pull-out force	Minimum pull-in force
	[mm]	[N]	[N]
	100	5.2	2.8
	125	4.6	2.5
	500	5.9	2.6
	1000	5.5	2.4
	1250	4.8	2.1
	1500	10.4	6.4
	2000	8.1	5.0
	2500	6.7	4.0
	3000	6.2	3.0

**Measurement range 100 ... 3000 mm, analog output, Dust-Explosion-proof**

Option S80

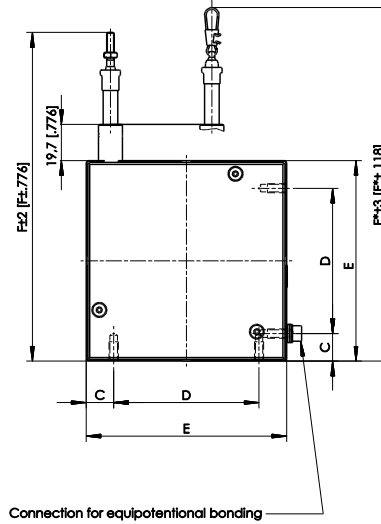
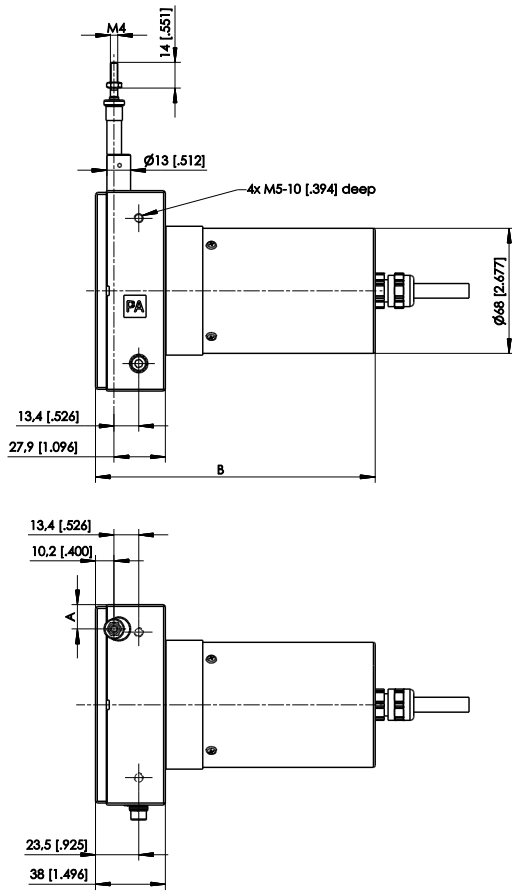

Dimensions in mm	Measurement range	A	B	C	D	E	F	F*
	100; 500; 1000	18.3	137	14	43	71	141	154
	125; 1250	14.5	137	14	43	71	141	154
	1500	10.7	152	14	43	71	141	154
	2000	21.5	152	15	79	109	179	192
	2500	13.3	152	15	79	109	179	192
	3000	9.2	152	15	79	109	179	192

Dimensions in mm [inch]  
 Dimensions informative only.  
 For guaranteed dimensions consult factory.

## Output specifications

### Analog outputs

#### Voltage divider R1K

Potentiometer 	Excitation voltage	24 V DC (32 V DC max. at 1 kΩ, max. power 1 W)
	Potentiometer impedance	1 kΩ ±10 %
	Thermal coefficient	±25 x 10 <sup>-6</sup> / °C f.s.
	Sensitivity	Depends on the measuring range, individual sensitivity of the sensor is specified on the label
	Voltage divider utilization range	approx. 3 % ... 97 %
	Operating temperature	Refer to output specification
	EMC	DIN EN 61326-1:2013

#### Output signals

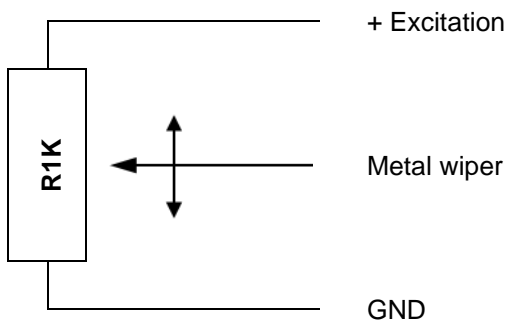

**Note:**

**The metal wiper of the potentiometer must be protected against current load!**

Electrical current flow impact on the wiper causes linearity errors and shortens the lifetime of the potentiometer.

Additional information:

[http://www.asm-sensor.com/asm/pdf/pro/ws\\_poti\\_technote\\_en.pdf](http://www.asm-sensor.com/asm/pdf/pro/ws_poti_technote_en.pdf)

#### Signal wiring

Signal	Connector pin no.	Cable color	Cable color
Poti +	1	white	brown
Poti GND	2	brown	white
Poti slider	3	green	blue
-	4	yellow	black
-	5	grey	-
-	6	pink	-
-	7	blue	-
-	8	red	-

**View to sensor connector**



CONN-M12-8F

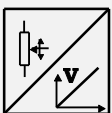

**Signal conditioner 10V**

Voltage output  	Excitation voltage	24 V DC non stabilized (18 ... 27 V DC )
	Excitation current	20 mA max.
	Output voltage	0 ... 10 V DC
	Output current	2 mA max.
	Output load	> 5 kΩ
	Stability (temperature)	±50 x 10 <sup>-6</sup> / °C f.s.
	Protection	Reverse polarity, short circuit
	Output noise	0.5 mV <sub>RMS</sub>
	Operating temperature	Refer to output specification
	EMV	DIN EN 61326-1:2013

**Output signals**

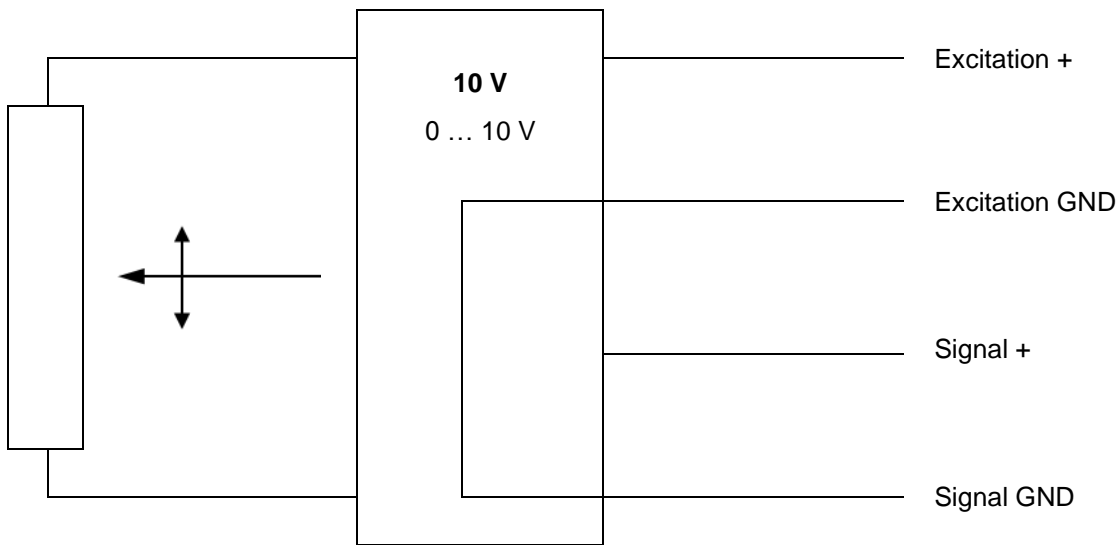

**Signal wiring**

Signal	Connector pin no.	Cable color	View to sensor connector
Excitation +	1	white	
Excitation GND	2	brown	
Signal +	3	green	
Signal GND	4	yellow	
Not connected	5	grey	
Not connected	6	pink	
Not connected	7	blue	
Not connected	8	red	

**Signal conditioner 420A**

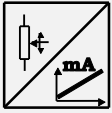
Current output (2 wire) 	Excitation voltage	24 V DC non stabilized (12 ... 27 V DC), measured at the sensor terminals
	Excitation current	35 mA max.
	Output current	4 ... 20 mA equivalent for 0 ... 100 % range
	Stability (temperature)	$\pm 100 \times 10^{-6} / ^\circ\text{C}$ f.s.
	Protection	Reversed polarity, short circuit
	Output noise	0.5 mV <sub>eff</sub>
	Operating temperature	Refer to output specification
	EMC	DIN EN 61326-1:2013

**Output signals**

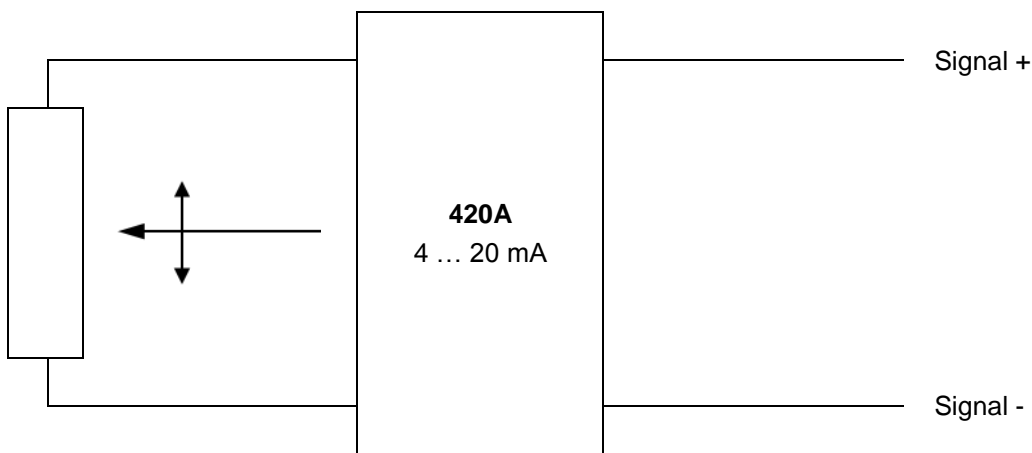

**Signal wiring**

Signal	Connector pin no.	Cable color	View to sensor connector
Signal +	1	white	 CONN-M12-8F
Signal -	2	brown	
Not connected	3	green	
Not connected	4	yellow	
Not connected	5	grey	
Not connected	6	pink	
Not connected	7	blue	
Not connected	8	red	

**Signal conditioner 420T**

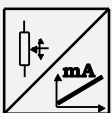
Current output (3 wire)	Excitation voltage	24 V DC non stabilized (18 ... 27 V DC)
	Excitation curren	40 mA max.
	Load resistor	350 Ω max.
	Output current	4 ... 20 mA equivalent for 0 ... 100 % range
	Stability (temperature)	±50 x 10 <sup>-6</sup> / °C f.s.
	Protection	Reverse polarity, short circuit
	Output noise	0.5 mV <sub>RMS</sub>
	Operating temperature	Refer to output specification
	EMC	DIN EN 61326-1:2013

**Output signals**

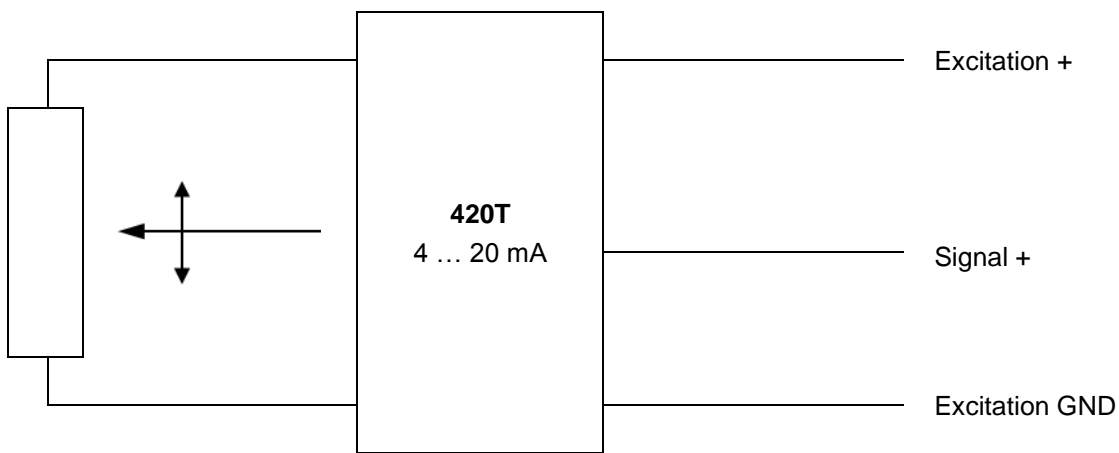

**Signal wiring**

Signal	Connector pin no.	Cable color	View to sensor connector
Excitation +	1	white	 <p>CONN-M12-8F</p>
Excitation GND	2	brown	
Signal +	3	green	
Not connected	4	yellow	
Not connected	5	grey	
Not connected	6	pink	
Not connected	7	blue	
Not connected	8	red	