



perfect in sensors.

POSIWIRE®

Cable Extension Position Sensors

**WS85 with internal magnetic encoder
Position Sensor**

Datasheet



Copyright

© ASM GmbH
Am Bleichbach 18-24
85452 Moosinning
Germany

The information presented in this data sheet does not form part of any quotation or contract, is believed to be accurate and reliable and may be changed without notice. No liability will be accepted by ASM for any consequence of its use. Publication thereof does not convey nor imply any license under patent or industrial or intellectual property rights. Applications that are described herein for any of these products are for illustrative purpose only.

ASM makes no representation or warranty that such applications will be suitable for the specified use without further testing or modification.

Magnetic encoder, analog output	4
Specifications	4
Order code	5
Magnetic encoder, analog output, programmable	6
Specifications	6
Order code	7
Magnetic encoder, analog output, redundant.....	8
Specifications	8
Order code	9
Magnetic encoder, digital output SSI	10
Specifications	10
Order code	11
Magnetic encoder, digital output CAN Bus.....	12
Specifications	12
Order code	13
Dimensions	14
Measurement range 4000 ... 6000 mm, magnetic encoder output	14
Output specification	15
Analog output	15
Analog output, programmable.....	17
Analog output, redundant.....	19
Digital output SSI	21
Digital output CANopen.....	23
Digital output CAN SAE J1939	24
Accessories.....	25
Connector cable M12, 4 pin	25
Connector cable M12, 5 pin	26
Connector cable M12, 8 pin	27
Connector/bus cable - M12, 5 pin CAN-Bus.....	28
T-piece for bus cable M12, 5 pin CAN-Bus.....	28
Terminating resistance M12, 5 pin CAN-Bus.....	28

Magnetic encoder, analog output

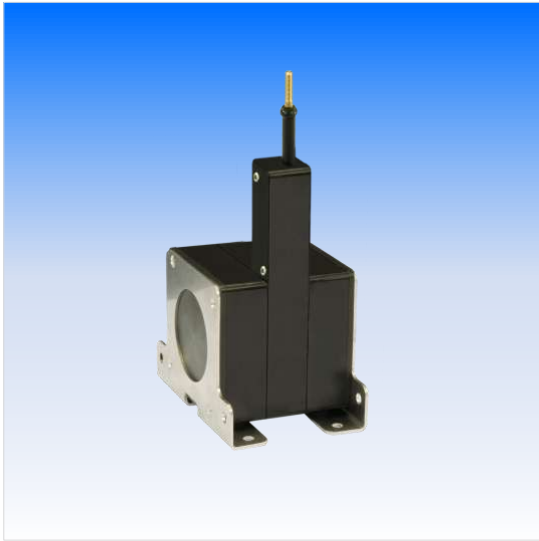

Sensor features

- With magnetic absolute encoder
- Measurement range up to 6000 mm
- Protection class IP67/IP69 (with mating connector only)
- Analog output
- Absolute measurement

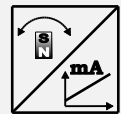
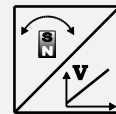

Specifications

Output	U2 = Voltage 0.5 ... 10 V U8 = Voltage 0.5 ... 4.5 V I1 = Current 4 ... 20 mA, 3 wire
Resolution	<0.002% f.s.
Linearity	±0.10% f.s. (standard) ±0.05% f.s. (optional)
Sensing device	Magnetic absolute encoder
Housing material	Plastic and stainless steel measuring cable: stainless steel
Protection class	IP67/IP69 (with mating connector only)
Connection	Connector M12, 5 pin
Shock	DIN EN 60068-2-27:2010, 100 g/11 ms, 100 shocks
Vibration	DIN EN 60068-2-6:2008, 20 g 10 Hz-2 kHz, 10 cycles
Temperature range	-40 ... +85 °C
Weight	Approx. 1250 g
EMC	DIN EN 61326-1:2013

Cable forces typical at = 20 °C	Measurement range	Maximum pull-out force	Minimum pull-in force
	[mm]	[N]	[N]
	4000	7.2	4.3
	5000	7.2	4.3
	6000	7.4	4.3

Order code

WS85 – 1 – 2 – 3 – 4 – 5 – 6

1 Measurement range (in mm)

4000 / 5000 / 6000

2 Output

U2 = Voltage 0.5 ... 10 V
U8 = Voltage 0.5 ... 4.5 V
I1 = Current 4 ... 20 mA, 3 wire

3 Signal characteristics

A = increasing signal (e.g. 4 ... 20 mA)
D = decreasing signal (e.g. 20 ... 4 mA)

4 Linearity

L10 = ±0.10% f.s. (standard)
L05 = ±0.05% f.s. (optional)

5 Cable fixing

M4 = M4 cable fixing
SB0 = cable clip

6 Connection

M12R5 = Connector M12, 5 pin

Order example

WS85 – 6000 – U2 – A – L10 – M4 – M12R5

Accessories:

Connector cable (see page 25)

Magnetic encoder, analog output, programmable

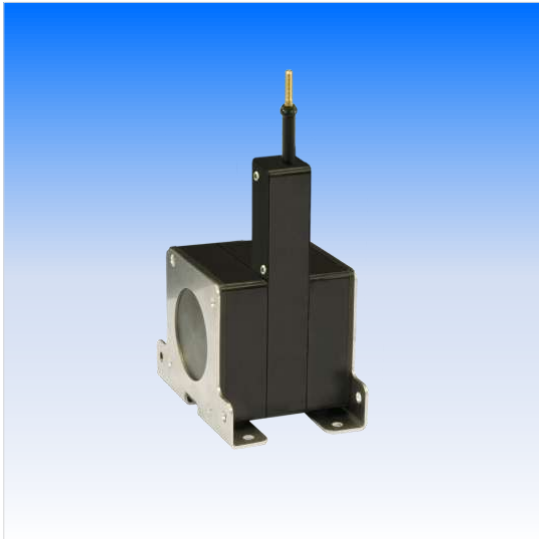

Sensor features

- With magnetic absolute encoder
- Measurement range up to 6000 mm
- Protection class IP67/IP69 (with mating connector only)
- Analog output, programmable
- Absolute measurement

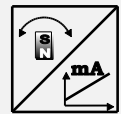
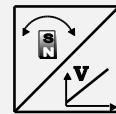

Specifications

Output	U2/PMU = Voltage 0.5 ... 10 V, programmable U8/PMU = Voltage 0.5 ... 4.5 V, programmable I1/PMU = Current 4 ... 20 mA, 3 wire, programmable
Resolution	<0.002% f.s.
Linearity	±0.10% f.s. (standard) ±0.05% f.s. (optional)
Sensing device	Magnetic absolute encoder
Housing material	Plastic and stainless steel measuring cable: stainless steel
Protection class	IP67/IP69 (with mating connector only)
Connection	Connector M12, 5 pin
Shock	DIN EN 60068-2-27:2010, 100 g/11 ms, 100 shocks
Vibration	DIN EN 60068-2-6:2008, 20 g 10 Hz-2 kHz, 10 cycles
Temperature range	-40 ... +85 °C
Weight	Approx. 1250 g
EMC	DIN EN 61326-1:2013

Cable forces typical at = 20 °C	Measurement range	Maximum pull-out force	Minimum pull-in force
	[mm]	[N]	[N]
	4000	7.2	4.3
	5000	7.2	4.3
	6000	7.4	4.3

Order code

WS85 – 1 – 2 – 3 – 4 – 5 – 6

1 Measurement range (in mm)

4000 / 5000 / 6000

2 Output

U2/PMU = Voltage 0.5 ... 10 V, programmable

U8/PMU = Voltage 0.5 ... 4.5 V, programmable

I1/PMU = Current 4 ... 20 mA, 3 wire, programmable

3 Signal characteristics

A = increasing signal (e.g. 4 ... 20 mA)

D = decreasing signal (e.g. 20 ... 4 mA)

4 Linearity

L10 = ±0.10% f.s. (standard)

L05 = ±0.05% f.s. (optional)

5 Cable fixing

M4 = M4 cable fixing

SB0 = cable clip

6 Connection

M12R5 = Connector M12, 5 pin

Order example

WS85 – 6000 – U2/PMU – A – L10 – M4 – M12R5

Accessories:

Connector cable (see page 26)

Magnetic encoder, analog output, redundant

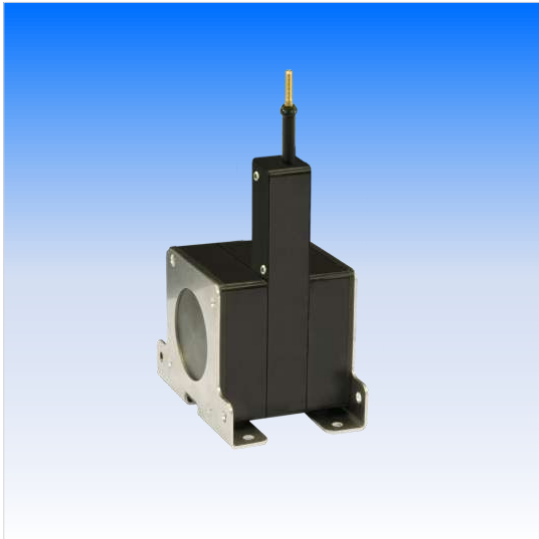

Sensor features

- With magnetic absolute encoder
- Measurement range up to 6000 mm
- Protection class IP67/IP69 (with mating connector only)
- Analog output, redundant
- Absolute measurement

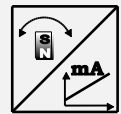
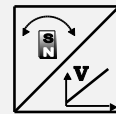

Specifications

Output	U2R U8R I1R	= Voltage 0.5 ... 10 V, redundant = Voltage 0.5 ... 4.5 V, redundant = Current 4 ... 20 mA, 3 wire, redundant
Resolution	<0.002% f.s.	
Linearity	±0.10% f.s. (standard) ±0.05% f.s. (optional)	
Sensing device	Magnetic absolute encoder	
Housing material	Plastic and stainless steel measuring cable: stainless steel	
Protection class	IP67/IP69 (with mating connector only)	
Connection	Connector M12, 8 pin	
Shock	DIN EN 60068-2-27:2010, 100 g/11 ms, 100 shocks	
Vibration	DIN EN 60068-2-6:2008, 20 g 10 Hz-2 kHz, 10 cycles	
Temperature range	-40 ... +85 °C	
Weight	Approx. 1250 g	
EMC	DIN EN 61326-1:2013	

Cable forces typical at = 20 °C	Measurement range	Maximum pull-out force	Minimum pull-in force
	[mm]	[N]	[N]
	4000	7.2	4.3
	5000	7.2	4.3
	6000	7.4	4.3

Order codeWS85 – 1 – 2 – 3 – 4 – 5 – 6**1 Measurement range (in mm)**

4000 / 5000 / 6000

2 Output

U2R = Voltage 0.5 ... 10 V, redundant
U8R = Voltage 0.5 ... 4.5 V, redundant
I1R = Current 4 ... 20 mA, 3 wire, redundant

3 Signal characteristics

A/A = Output 1 increasing, output 2 increasing
A/D = Output 1 increasing, output 2 decreasing
D/D = Output 1 decreasing, output 2 decreasing

4 Linearity

L10 = ±0.10% f.s. (standard)
L05 = ±0.05% f.s. (optional)

5 Cable fixing

M4 = M4 cable fixing
SB0 = cable clip

6 Connection

M12R8 = Connector M12, 8 pin

Order example

WS85 – 6000 – I1R – A/D – L10 – M4 – M12R8
--

Accessories:**Connector cable (see page 27)**

Magnetic encoder, digital output SSI

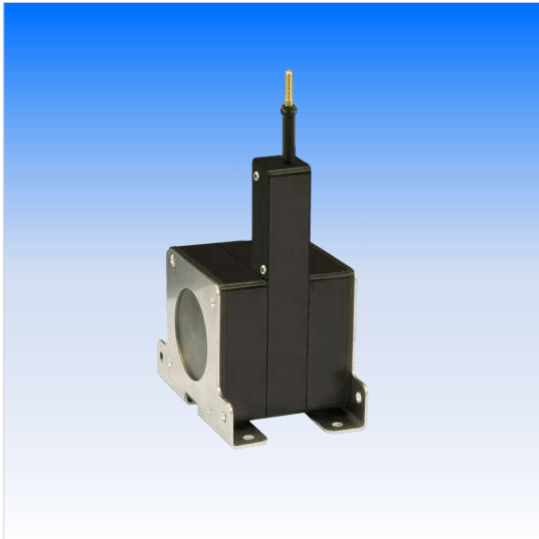

Sensor features

- With magnetic absolute encoder
- Measurement range up to 6000 mm
- Protection class IP67/IP69 (with mating connector only)
- Digital output SSI
- Absolute measurement

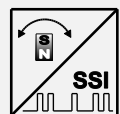

Specifications

Output	MSSI = SSI synchronous serial interface
Resolution	50 / 100
Linearity	±0.10% f.s. (standard) ±0.05% f.s. (optional)
Sensing device	Magnetic absolute encoder
Housing material	Plastic and stainless steel measuring cable: stainless steel
Protection class	IP67/IP69 (with mating connector only)
Connection	Connector M12, 8 pin
Shock	DIN EN 60068-2-27:2010, 100 g/11 ms, 100 shocks
Vibration	DIN EN 60068-2-6:2008, 20 g 10 Hz-2 kHz, 10 cycles
Temperature range	-40 ... +85 °C
Weight	Approx. 1250 g
EMC	DIN EN 61326-1:2013

Cable forces typical at = 20 °C	Measurement range	Maximum pull-out force	Minimum pull-in force
	[mm]	[N]	[N]
	4000	7.2	4.3
	5000	7.2	4.3
	6000	7.4	4.3

Order code

WS85 – 1 – 2 – 3 – 4 – 5 – 6

1 Measurement range (in mm)

4000 / 5000 / 6000

2 Resolution (in µm)

50 / 100

3 Output

MSSI = SSI synchronous serial interface

4 Linearity

L10 = ±0.10% f.s. (standard)
L05 = ±0.05% f.s. (optional)

5 Cable fixing

M4 = M4 cable fixing
SB0 = cable clip

6 Connection

M12R8 = Connector M12, 8 pin

Order example

WS85 – 6000 – 50 – MSSI – L10 – M4 – M12R8

Accessories:

Connector cable (see page 27)

Magnetic encoder, digital output CAN Bus

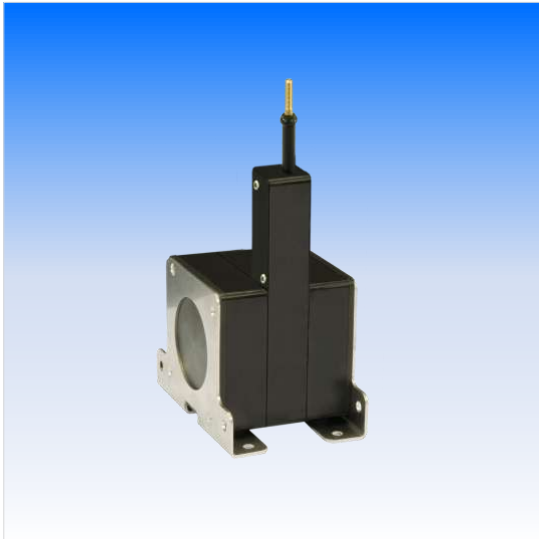

Sensor features

- With magnetic absolute encoder
- Measurement range up to 6000 mm
- Protection class IP67/IP69 (with mating connector only)
- Digital output CAN Bus
- Absolute measurement
- Optional redundant CAN Bus



Specifications

Output	MCANOP = CANopen MCANJ1939 = CAN SAE J1939 MCANOPR = CANopen redundant MCANJ1939R = CAN SAE J1939 redundant
Resolution	setting via CAN Bus
Linearity	±0.10% f.s. (standard) ±0.05% f.s. (optional)
Sensing device	Magnetic absolute encoder
Housing material	Plastic and stainless steel measuring cable: stainless steel
Protection class	IP67/IP69 (with mating connector only)
Connection	Connector M12, 5 pin
Temperature range	-40 ... +85 °C
Weight	Approx. 1250 g
EMC	DIN EN 61326-1:2013

Cable forces typical at = 20 °C	Measurement range	Maximum pull-out force	Minimum pull-in force
	[mm]	[N]	[N]
	4000	7.2	4.3
	5000	7.2	4.3
	6000	7.4	4.3

Order code

WS85 – 1 – 2 – 3 – 4 – 5

1 Measurement range (in mm)

4000 / 5000 / 6000

2 Output

MCANOP = CANopen
MCANJ1939 = CAN SAE J1939
MCANOPR = CANopen redundant
MCANJ1939R = CAN SAE J1939 redundant

3 Linearity

L10 = ±0.10% f.s. (standard)
L05 = ±0.05% f.s. (optional)

4 Cable fixing

M4 = M4 cable fixing
SB0 = cable clip

5 Connection

M12/CAN = Connector M12, 5 pin

Order example

WS85 – 6000 – MCANOP – L10 – M4 – M12/CAN

Accessories:

Connector cable (see page 28)

Dimensions

Measurement range 4000 ... 6000 mm, magnetic encoder output

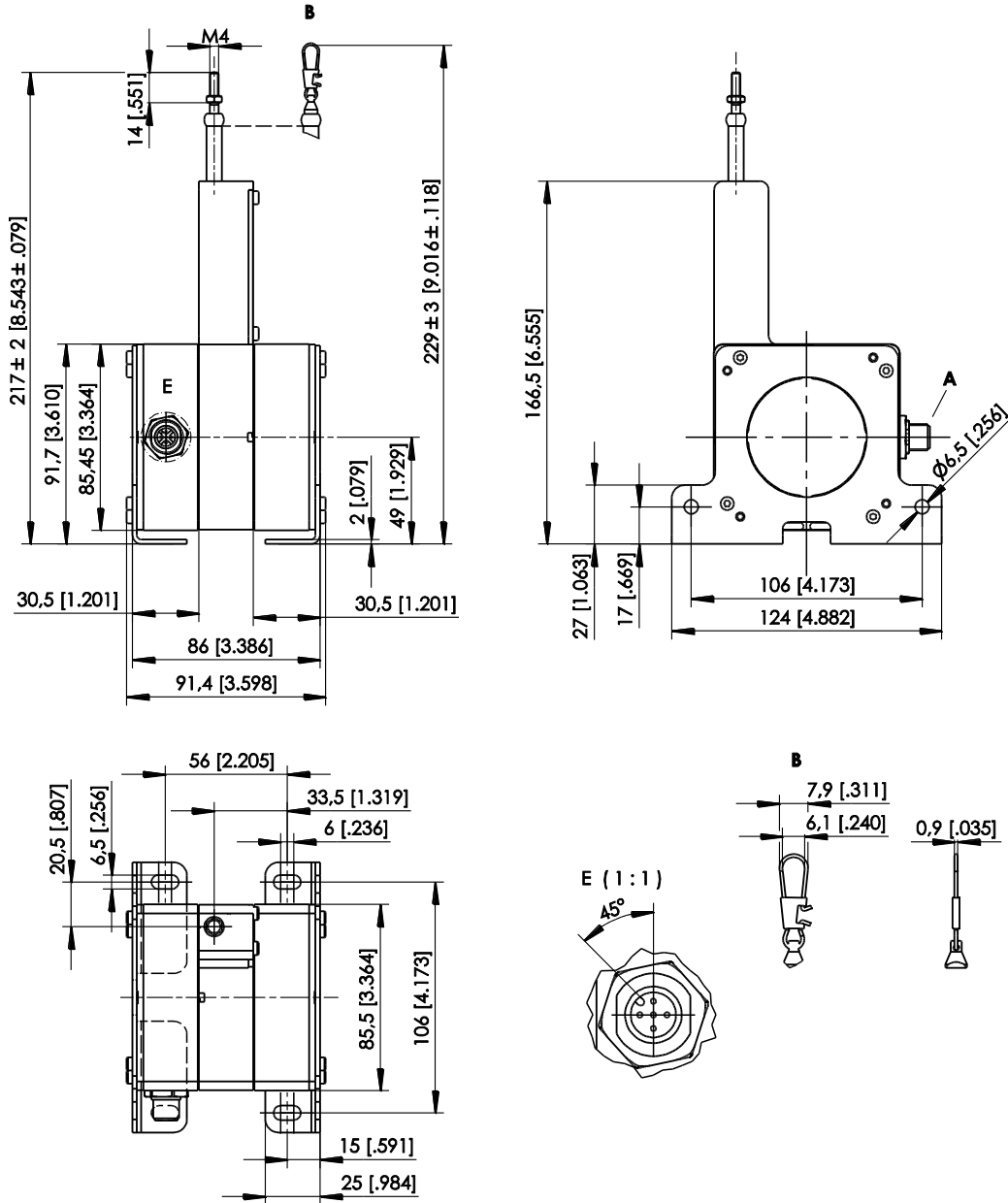

A – Connector M12

B – Option SB0

Dimensions in mm [inch]

Dimensions informative only.

For guaranteed dimensions consult factory.

Output specification

Analog output

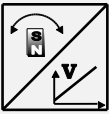
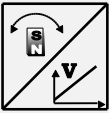
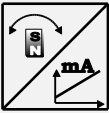
U2 Voltage output 0.5 ... 10 V 	Excitation voltage	8 ... 36 V DC
	Excitation current	20 mA typical at 24 V DC 38 mA typical at 12 V DC max. 50 mA
	Output voltage	0.5 ... 10 V DC
	Output current	2 mA max.
	Measuring rate	1 kHz standard
	Stability (temperature)	$\pm 50 \times 10^{-6}$ / °C f.s. (typical)
	Protection	Reverse polarity, short circuit
	Operating temperature	See specification of the respective sensor
	EMC	DIN EN 61326-1:2013
U8 Voltage output 0.5 ... 4.5 V 	Excitation voltage	8 ... 36 V DC
	Excitation current	17 mA typical at 24 V DC 32 mA typical at 12 V DC 50 mA max.
	Output voltage	0.5 ... 4.5 V DC
	Output current	2 mA max.
	Measuring rate	1 kHz standard
	Stability (temperature)	$\pm 50 \times 10^{-6}$ / °C f.s. (typical)
	Protection	Reverse polarity, short circuit
	Operating temperature	See specification of the respective sensor
	EMC	DIN EN 61326-1:2013
I1 Current output 4 ... 20 mA, 3 wires 	Excitation voltage	8 ... 36 V DC
	Excitation current	typical 36 mA at 24 V DC typical 70 mA at 12 V DC 120 mA max.
	Load R _L	500 Ω max.
	Output current	4 ... 20 mA
	Measuring rate	1 kHz standard
	Stability (temperature)	$\pm 50 \times 10^{-6}$ / °C f.s. (typical)
	Protection	Reverse polarity, short circuit
	Operating temperature	See specification of the respective sensor
	EMC	DIN EN 61326-1:2013

Signal wiring

Signal	Connector pin no.	Cable connection	View to the sensor connector
Excitation +	1	brown	
Signal	2	white	
GND	3	blue	
Do not connect!	4	black	
Do not connect!	5	(grey)	

Signal diagram

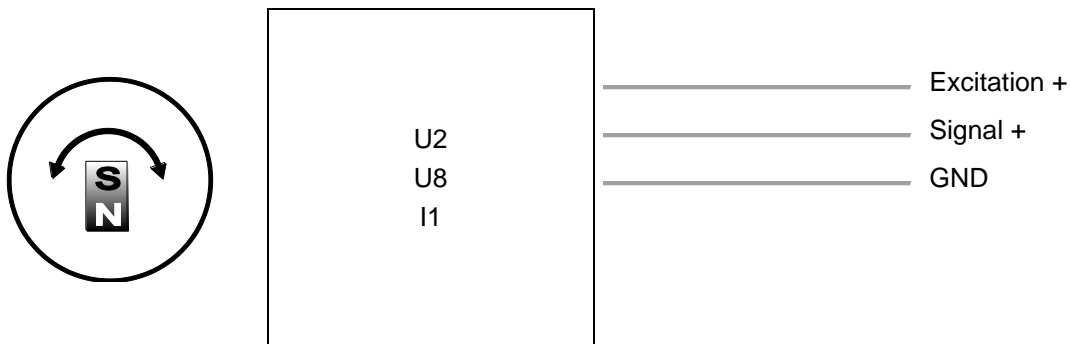

Analog output, programmable

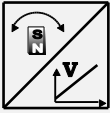
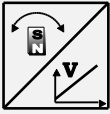
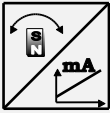
<p>U2/PMU</p> <p>Voltage output 0.5 ... 10 V</p> 	Excitation voltage	8 ... 36 V DC
	Excitation current	20 mA typical at 24 V DC 38 mA typical at 12 V DC max. 50 mA
	Output voltage	0,5 ... 10 V DC
	Output current	2 mA max.
	Measuring rate	1 kHz standard
	Stability (temperature)	$\pm 50 \times 10^{-6} / ^\circ\text{C}$ f.s. (typical)
	Protection	Reverse polarity, short circuit
	Operating temperature	See specification of the respective sensor
	EMC	EN 61326-1:2013
	<p>U8/PMU</p> <p>Voltage output 0.5 ... 4.5 V</p> 	Excitation voltage
Excitation current		17 mA typical at 24 V DC 32 mA typical at 12 V DC max. 50 mA
Output voltage		0.5 ... 4.5 V DC
Output current		2 mA max.
Measuring rate		1 kHz standard
Stabilität (Temperatur)		$\pm 50 \times 10^{-6} / ^\circ\text{C}$ f.s. (typical)
Protection		Reverse polarity, short circuit
Operating temperature		See specification of the respective sensor
EMC		DIN EN 61326-1:2013
<p>I1/PMU</p> <p>Current output 4 ... 20 mA, 3 wires</p> 		Excitation voltage
	Excitation current	typical 36 mA at 24 V DC typical 70 mA at 12 V DC max. 120 mA
	Load R _L	500 Ω max.
	Output current	4 ... 20 mA
	Measuring rate	1 kHz standard
	Stability (temperature)	$\pm 50 \times 10^{-6} / ^\circ\text{C}$ f.s. (typical)
	Protection	Reverse polarity, short circuit
	Operating temperature	See specification of the respective sensor
	EMC	DIN EN 61326-1:2013

Signal wiring

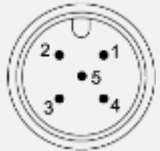
Signal	Connector pin no.	Cable color	View to sensor connector
Excitation +	1	brown	
Signal	2	white	
GND	3	blue	
Do not connect!	4	black	
SPAN/ZERO	5	grey	

Signal diagram

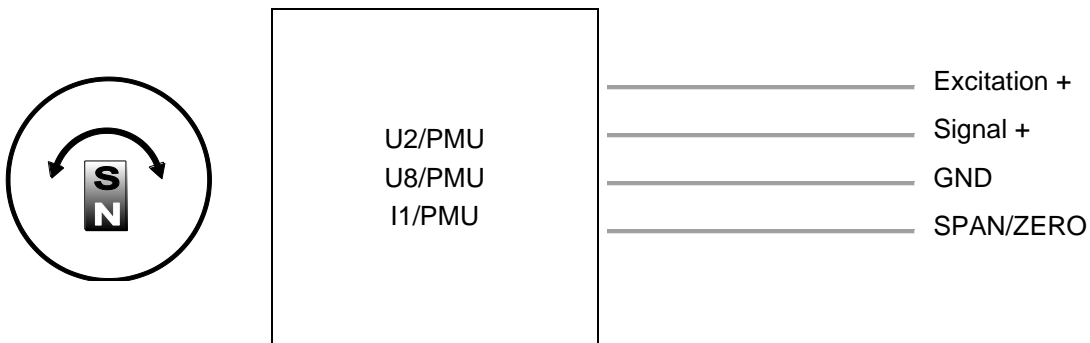

Option -PMU

Programming of the start and end value by the customer

Teach-In of start and end value for the options U2/PMU, I1/PMU, U8/PMU is provided by a binary signal SPAN/ZERO. At the start position connect signal SPAN/ZERO for a period of 2 ... 3 seconds to GND via push button. At the end position connect signal SPAN/ZERO for a period of 5 ... 6 seconds to GND via a push button. The scaling taught in that way will be stored non-volatile.

To reset the sensor to factory default signal ZERO/END must be connected to ground while powering up the sensor for 2 ... 3 seconds. For the option PMZ only teach-in of ZERO position is possible.

Analog output, redundant

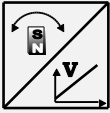
<p>U2R</p> <p>Voltage output 0.5 ... 10 V</p> 	Excitation voltage	8 ... 36 V DC
	Excitation current	20 mA typical at 24 V DC 38 mA typical at 12 V DC max. 50 mA per channel
	Output voltage	0.5 ... 10 V DC
	Output current	2 mA max.
	Measuring rate	1 kHz standard
	Stability (temperature)	$\pm 50 \times 10^{-6} / ^\circ\text{C}$ f.s. (typical)
	Protection	Reverse polarity, short circuit
	Operating temperature	See specification of the respective sensor
	EMC	DIN EN 61326-1:2013

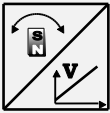
<p>U8R</p> <p>Voltage output 0.5 ... 4.5 V</p> 	Excitation voltage	8 ... 36 V DC
	Excitation current	17 mA typical at 24 V DC 32 mA typical at 12 V DC max. 50 mA per channel
	Output voltage	0.5 ... 4.5 V DC
	Output current	2 mA max.
	Measuring rate	1 kHz standard
	Stability (temperature)	$\pm 50 \times 10^{-6} / ^\circ\text{C}$ f.s. (typical)
	Protection	Reverse polarity, short circuit
	Operating temperature	See specification of the respective sensor
	EMC	DIN EN 61326-1:2013

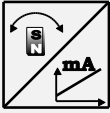
<p>I1R</p> <p>Current output 4 ... 20 mA, 3 wires</p> 	Excitation voltage	8 ... 36 V DC
	Excitation current	36 mA typical at 24 V DC 76 mA typical at 12 V DC max. 120 mA per channel
	Load R_L	500 Ω max.
	Output current	4 ... 20 mA
	Measuring rate	1 kHz standard
	Stability (temperature)	$\pm 50 \times 10^{-6} / ^\circ\text{C}$ f.s. (typical)
	Protection	Reverse polarity, short circuit
	Operating temperature	See specification of the respective sensor
	EMC	DIN EN 61326-1:2013

Signal wiring

Channel	Signal	Connector pin no.	Cable color	View to the sensor connector
1	Excitation +	1	white	
1	Signal	2	brown	
1	GND	3	green	
1	Do not connect!	4	yellow	
2	Excitation +	5	grey	
2	Signal	6	pink	
2	GND	7	blue	
2	Do not connect!	8	red	

Signal diagram

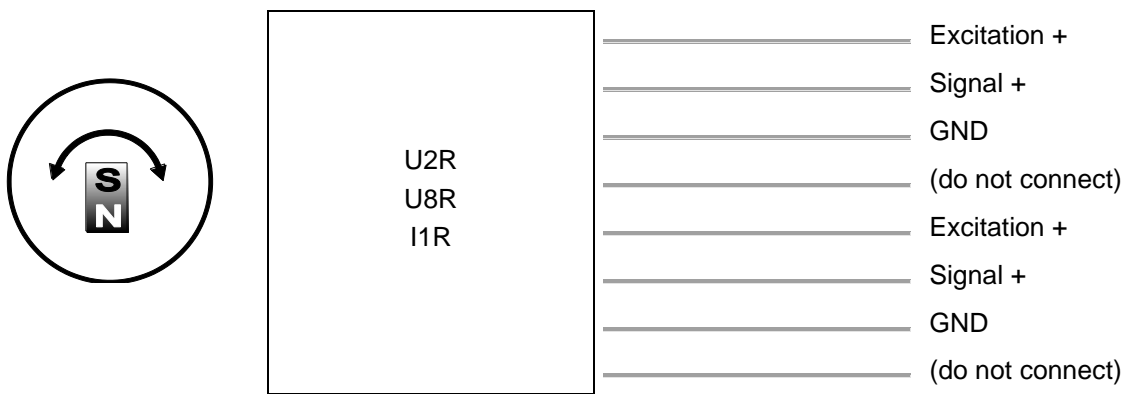

Digital output SSI

MSSI Synchronous serial SSI 	Interface	EIA RS-422
	Excitation voltage	8 ... 36 V DC
	Excitation current	19 mA typical at 24 V DC 35 mA typical at 12 V DC max. 80 mA
	Clock frequency	100 kHz ... 500 kHz
	Code	Gray-Code, continuous progression
	Delay between pulse trains (t_p)	30 μ s min.
	Stability (temperature)	$\pm 50 \times 10^{-6}$ / °C f.s. (typical)
	Operating temperature	See specification of the respective sensor
	Protection	Reverse polarity, short circuit
	EMC	DIN EN 61326-1:2013

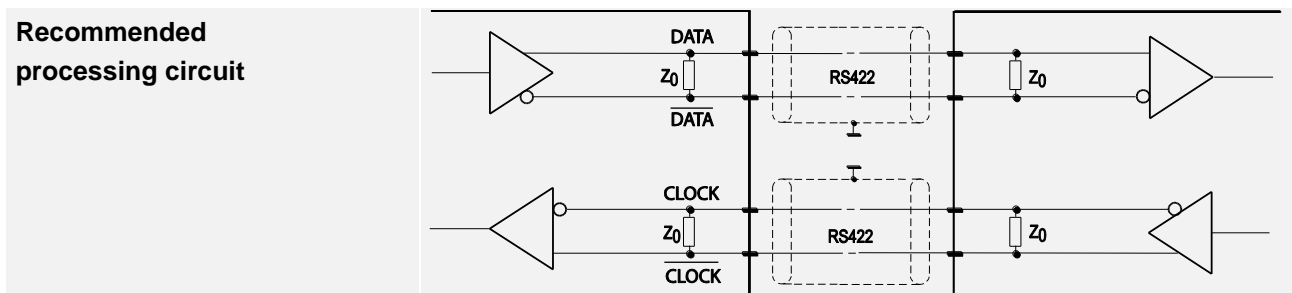
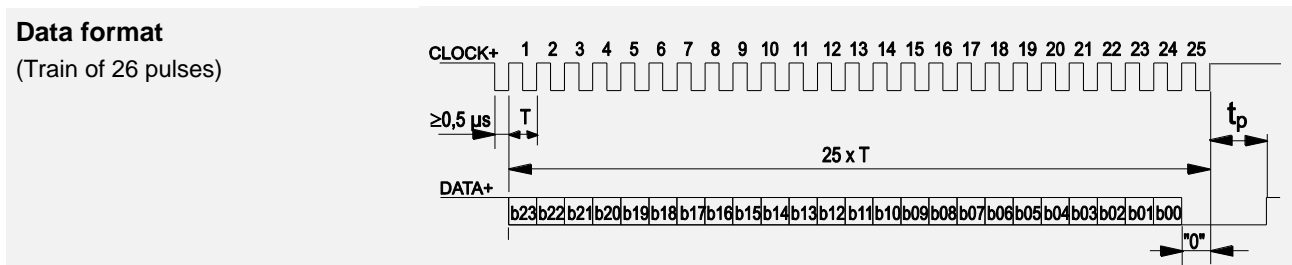

Transmission rate	Cable length	Baud rate
	50 m	100-400 kHz
	100 m	100-300 kHz

Note:
Extension of the cable length will reduce the maximum transmission rate.

Signal wiring

Signal	Connector pin no.	Cable color	View to sensor connector
Excitation +	1	white	
Excitation GND	2	brown	
CLOCK	3	green	
$\overline{\text{CLOCK}}$	4	yellow	
DATA	5	grey	
$\overline{\text{DATA}}$	6	pink	
-	7	blue	
-	8	red	

Digital output CANopen

MCANOP, CANOPR CANopen 	CAN specification	ISO 11898, Basic and Full CAN 2.0 B
	Communication profile	CANopen CiA 301 V 4.02, Slave
	Encoder profile	Encoder CiA 406 V 3.2
	Error Control	Node Guarding, Heartbeat, Emergency Message
	Node ID	Adjustable via LSS, default: 127
	PDO	3 TxPDO, 0 RxPDO, no linking, static mapping
	PDO Modes	Event-/Time triggered, Remote-request, Sync cyclic/acyclic
	SDO	1 Server, 0 Client
	CAM	8 cams
	Certified	Yes
	Transmission rate	50 kBit bis 1 Mbit, adjustable via LSS, default: 125 kBit
	Bus connection	M12 connector, 5 pin
	Integrated bus terminating resistor	120Ω adjustable by the customer
	Bus, galvanic isolated	no

Specifications	Excitation voltage	8 ... 36 V DC
	Excitation current	20 mA typical at 24 V DC 40 mA typical at 12 V DC 80 mA max.
	Measuring rate	1 kHz (asynchronous)
	Stability (temperature)	±50 x 10 ⁻⁶ /°C f.s. (typical)
	Repeatability	1 LSB
	Operating temperature	See specification of the respective sensor
	Protection	Reverse polarity, short circuit
	Dielectric strength	1 kV (V AC, 50 Hz, 1 min.)
	EMC	EN 61326-1:2013

Signal wiring	Signal	Connector pin no.	View to the sensor connector
	Shield	1	
	Excitation +	2	
	GND	3	
	CAN-H	4	
	CAN-L	5	

Digital output CAN SAE J1939

MCANJ1939/R CAN SAE J1939 	CAN Specification	ISO 11898, Basic and Full CAN 2.0 B
	Transceiver	24V-compliant, not isolated
	Communication profile	SAE J1939
	Baud Rate	250 kbit/s
	Internal termination resistor	120 Ω adjustable by the customer
	Address	Default 247d, configurable

NAME Fields	Arbitrary address capable	1	Yes
	Industry group	0	Global
	Vehicle system	7Fh (127d)	Non specific
	Vehicle system instance	0	
	Function	FFh (255d)	Non specific
	Function instance	0	
	ECU instance	0	
	Manufacturer	145h (325d)	Manufacturer ID
	Identity number	0nnn	Serial number 21 bit

Parameter Group Numbers (PGN)	Configuration data	PGN EF00h	Proprietary-A (PDU1 peer-to-peer)
	Process data	PGN FFnnh	Proprietary-B (PDU2 broadcast); nn Group Extension (PS) configurable

Specifications	Excitation voltage	8 ... 36 V DC
	Excitation current	20 mA typical at 24 V DC 40 mA typical at 12 V DC, max. 80 mA
	Measuring rate	1 kHz (asynchronous)
	Stability (temperature)	±50 x 10 ⁻⁶ /°C f.s. (typical)
	Repeatability	1 LSB
	Operating temperature	See specification of the respective sensor
	Protection	Reverse polarity, short circuit
	Dielectric strength	1 kV (V AC, 50 Hz, 1 min.)
EMV	EN 61326-1:2013	

Signal wiring	Signal	Connector pin no.	View to the sensor connector
	Shield	1	
	Excitation +	2	
	GND	3	
	CAN-H	4	
	CAN-L	5	

Accessories

Connector cable M12, 4 pin

(angular coupling)

shielded connector

Suitable for 5-pin sensor connectors

The 4-core screened cable is supplied with a mating 4-pin 90° M12 connector at one end and 4 wires at the other end. Available lengths are 2m, 5m and 10m. Wire: cross sectional area 0.34mm² Cable diameter: 5.6 ±0.2 mm

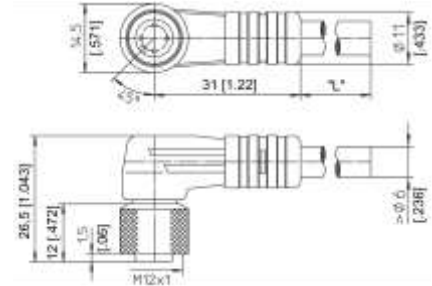

Order code

KAB - xM - M12/4F/W - LITZE

IP69: **KAB - xM - M12/4F/W/69K - LITZE**

xM = length in m

Connector cable M12, 4 pin

(straight coupling)

shielded connector

Suitable for 5-pin sensor connectors

The 4-core screened cable is supplied with a mating 4-pin M12 connector at one end and 4 wires at the other end. Available lengths are 2m, 5m and 10m. Wire: cross sectional area 0.34mm² Cable diameter: 5.6 ±0.2 mm

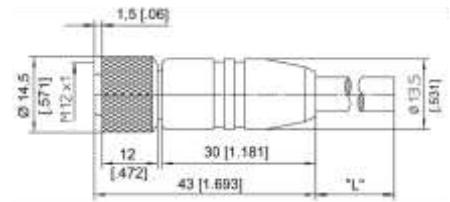

Order code

KAB - xM - M12/4F/G - LITZE

IP69: **KAB - xM - M12/4F/G/69K - LITZE**

xM = length in m

Signal wiring	Plug connection / cable color			
	M12, 4 pin	1 brown	2 white	3 blue

Applicable for cable carriers

Maximum movement speed	3 m/s
Maximum acceleration	5 m/s ²
Minimum bending radius	10 x cable diameter

**Connector cable M12, 5 pin
(angular coupling)**

shielded connector

The 5-core screened cable is supplied with a mating 5-pin 90° M12 connector at one end and 4 wires at the other end. Available lengths are 2m, 5m and 10m. Wire: cross sectional area 0.34mm² Cable diameter: 5.6 ±0.2mm

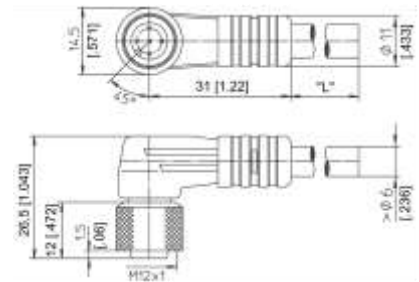

Order code

KAB - xM - M12/5F/W - LITZE

IP69: **KAB - xM - M12/5F/W/69K - LITZE**

xM = length in m

**Connector cable M12, 5 pin
(straight coupling)**

shielded connector

The 5-core screened cable is supplied with a mating 5-pin M12 connector at one end and 4 wires at the other end. Available lengths are 2m, 5m and 10m. Wire: cross sectional area 0.34mm² Cable diameter: 5.6 ±0.2mm

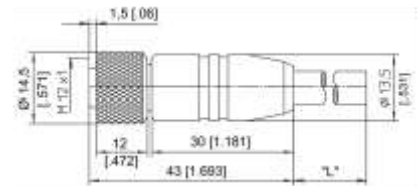

Order code

KAB - xM - M12/5F/G - LITZE

IP69: **KAB - xM - M12/5F/G/69K - LITZE**

xM = length in m

Signal wiring M12, 5 pin	Plug connection / Cable color				
	1	2	3	4	5
	brown	white	blue	black	grey

Applicable for cable carriers

Maximum movement speed	3 m/s
Maximum acceleration	5 m/s ²
Minimum bending radius	10 x cable diameter

**Connector cable M12, 8 pin
(angular coupling)**

shielded connector

The 8-lead shielded cable is supplied with a mating 8-pin 90° M12 connector at one end and 8 wires at the other end. Available lengths are 2m, 5m and 10m. Wire: cross sectional area 0.25mm² Cable diameter: 6.3 ±0.2mm

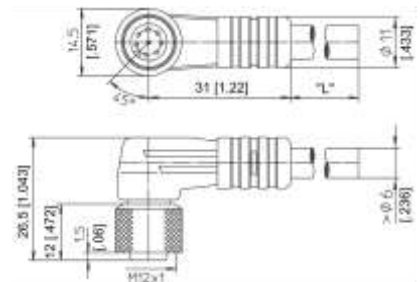

Order code

KAB - xM - M12/8F/W - LITZE

IP69: **KAB - xM - M12/8F/W/69K - LITZE**

xM = length in m

**Connector cable M12, 8 pin
(straight coupling)**

shielded connector

The 8-lead shielded cable is supplied with a mating 8-pin M12 connector at one end and 8 wires at the other end. Available lengths are 2m, 5m and 10m. Wire: cross sectional area 0.25mm² Cable diameter: 6.3 ±0.2mm

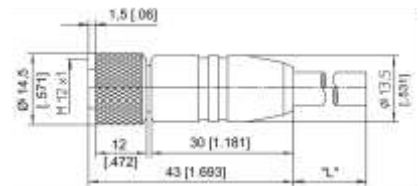

Order code

KAB - xM - M12/8F/G - LITZE

IP69: **KAB - xM - M12/8F/G/69K - LITZE**

xM = length in m

Signal wiring	Plug connection / cable color							
	1	2	3	4	5	6	7	8
M12, 8 pin	white	brown	green	yellow	grey	pink	blue	red

Applicable for cable carriers

Maximum movement speed	3 m/s
Maximum acceleration	5 m/s ²
Minimum bending radius	10 x cable diameter

Connector/bus cable - M12, 5 pin CAN-Bus

The 5-lead shielded cable is supplied with a female 5 pin M12 connector at one end and a male 5 pin M12 connector at the other end.

Available lengths are 0.3 m, 2 m, 5 and 10 m.

Cable diameter: 6.7 ±0.2 mm

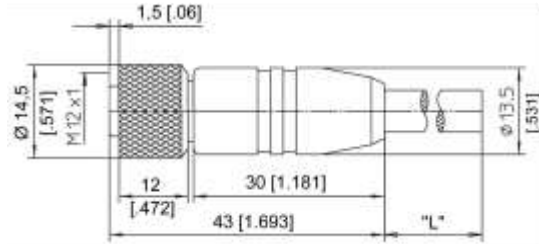

Order code:

KAB - xM - M12/5F/G - M12/5M/G - CAN

IP69: **KAB - xM - M12/5F/G/69K - M12/5M/G/69K - CAN**

xM = length in m

T-piece for bus cable M12, 5 pin CAN-Bus

Order code:

KAB - TCONN - M12/5M - 2M12/5F - CAN



Terminating resistance M12, 5 pin CAN-Bus

Order code:

KAB - RTERM - M12/5M/G - CAN



Applicable for cable carriers

Maximum movement speed	3 m/s
Maximum acceleration	5 m/s ²
Minimum bending radius	10 x cable diameter