

**Interchangeable, Rugged
Uniaxial Angular Rate Gyro
with 0.5% Typical
Accuracy over
-40 to +85°C range**

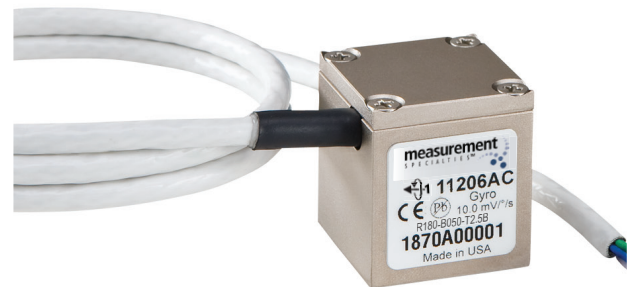

Technical Data*

Features and Benefits

IdentiCal™ Interchangeable Sensors



IdentiCal™ Interchangeable Sensors eliminate the management of calibration data and allow convenient interchangeability of individual sensors. With standardized sensitivity and offset, there is no need to enter new parameters for each unit. Perfect for high volume use.

Rugged for Harsh Environments

The 11206AC is robust to perform well in harsh environments. The 6061-T6 case with electroless nickel finish plus a PTFE cable with a shield bonded to the case provide improved resistance to EMI, lightning, or other disturbances. The enclosure is rated IP65. The unit has resilient power and will survive 1500 g powered and unpowered.

High Accuracy and Linearity over Wide Temperature Range

The output of the 11206AC is directly proportional to the rotational rate about its axis. The DC-coupled output is fully scaled, referenced, and temperature compensated. When used in demanding temperature environments, gain compensation makes the 11206AC one of the most accurate angular rate gyros available.

Small Size

Complete conditioned rate gyro in less than a cubic inch.

Built-In Power Supply Regulation

Unregulated DC power from +8.5 to +36 Volts is all that is required to measure rotational rates (min. 12 V for Option L001). The 11206AC is operational with transients of +80V for 550 ms compatible with MIL-STD-704A.

Earth Friendly Design

Lead-free design makes the 11206AC environmentally safe while Measurement Specialties' assembly process ensures reliable functionality. Fully potted electronics eliminates the possibility of failures due to tin whiskers.

Three Year Warranty

Measurement Specialties' 11206AC rate sensors are covered by a three year return to factory warranty. Extended warranties are available.

**Precisely Measure Rates
Over Temperature**

The Measurement Specialties' 11206AC rugged uniaxial angular rate gyro is capable of accurately measuring angular rate under varied environmental conditions. A tough, compact housing holds potted electronics and a shielded 22 AWG cable. Its cubical form allows mounting with the sensing axis oriented in any direction.

The 11206AC provides enhanced accuracy and durability features to meet the challenges of your application. In addition to its robust construction, increased precision is achieved through improved offset and gain compensation.

Each axial sensor has been tested over the -40 to +85°C temperature range and has a nominal full scale output swing of ±2.25 Volts. The zero rate output level is nominally +2.5 Volts. The 11206AC can be ordered in configurations with different ranges, bandwidths, or other I/O considerations.

**Data subject to change without notice*

Specifications for 11206AC - improved specifications available upon request

$T_A = T_{MIN}$ to T_{MAX} ; $8.5 \leq V_S \leq 36$ V; Acceleration = ± 1 g, Angular Rate = $0^\circ/\text{sec}$ unless otherwise noted; within one year of calibration.

Parameter	Min	Typical	Max	Units	Conditions/Notes
Range & Sensitivity* at 25°C					Must specify via Option Rnnn, see Ordering Info
Option R600		3.0		mV/°/sec	
Option R300		6.0		mV/°/sec	
Option R180		10.0		mV/°/sec	
Option R050		25.0		mV/°/sec	
Sensitivity Drift 25°C to T_{MIN} or T_{MAX}			1.0	% FSR	
Offset at 25°C Zero g Bias Level		2.500		V	
Offset Drift 25°C to T_{MIN} or T_{MAX}		± 3.0	± 6.0	°/sec	
Alignment Deviation from Ideal Axes		± 1.5		degrees	
g Sensitivity		0.2		°/sec/g	Affects offset
Nonlinearity		0.1		% FSR	Best fit straight line
Frequency Response	0		100	Hz	Upper cutoff per Option Bnnn, -3dB pt $\pm 10\%$
Noise Density		0.05		°/sec/ $\sqrt{\text{Hz}}$	$T_A = 25^\circ\text{C}$
Outputs Output Voltage Swing	0.25		4.75	V	$I_{OUT} = 1$ mA, Capacitive load < 1000 pF
Power Supply (Vs) Input Voltage Limits	-80		+80	V	-80V continuous, >38 V if ≤ 550 ms, duty < 1%
Input Voltage - Operating, Option L000	+8.5		+36	V	
Input Voltage - Operating, Option L001	+12		+36	V	
Input Current		10		mA	No load, quiescent
Rejection Ratio		>120		dB	DC
Temperature Range (T_A)	-40		+85	°C	
Mass		38		grams	
Shock Survival	-1500		+1500	g	Any axis for 0.5 ms, powered or unpowered

Data subject to change without notice

*Identical sensors are interchangeable, any with same range have same value

Ordering Information

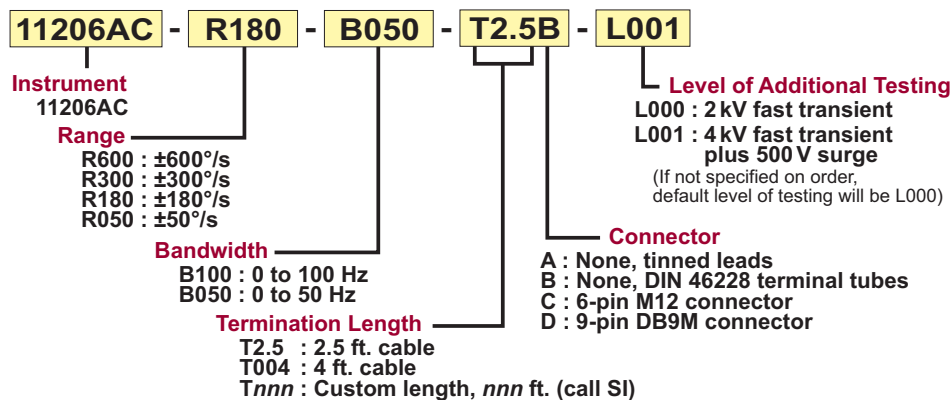

Connections

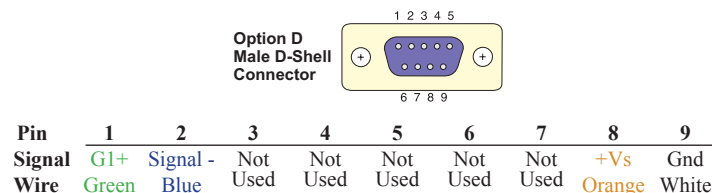

11206AC Mechanical

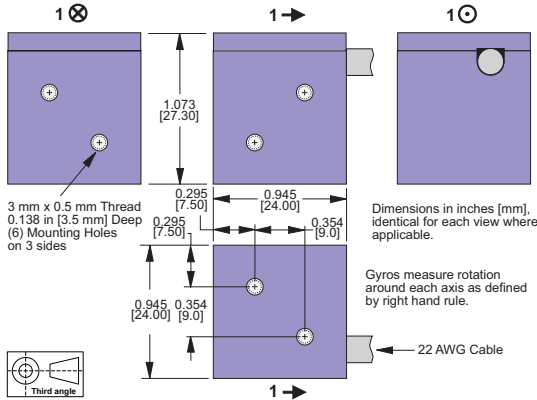

6061-T6 aluminum case
with electroless nickel finish
plus integrated cable with
shield bonded at the case.

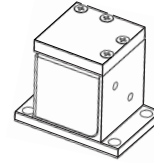

Shown with mounting
adapter 34170B (sold
separately)

Product Testing

Conditions	Reference Standard	OPTION		Levels
		1000	1001	
EMC- Electromagnetic Compatibility Directive: 89/336/EEC, as amended by 2004/108/EC				
EN 61000-6-2: Immunity for Industrial Environments	EN 61000-4-2	✓	✓	Electrostatic Discharge: 8 kV air discharge, 4 kV contact mode
	EN 61000-4-3	✓	✓	Radio Frequency Interference: 10 V/m (80 MHz - 1 GHz), 3 V/m (1 GHz - 2.5 GHz), 1 V/m (2.5 GHz - 2.7 GHz)
	EN 61000-4-4	✓	✓	Electric Fast Transients: 2 kV (signal lines) ✓ Electric Fast Transients: 4 kV (power lines)
	EN 61000-4-5	✓	✓	Surge: 4 kV on metal enclosure and shield ✓ Surge: 0.5 kV on power lines
	EN 61000-4-6	✓	✓	Conducted Radio Frequency: 10 V (150 kHz - 80 MHz)
	EN 61000-4-8	✓	✓	Low Frequency Magnetic Field: 100 A (50, 60 Hz)
	EN 61000-4-9	✓	✓	Pulse Magnetic Field: 1000 A/m (8/20 μs)
	EN 61000-4-10	✓	✓	Damped Oscillatory Magnetic Field: 100 A/m (100 kHz)
	EN 61000-4-29	✓	✓	Voltage Dips, Short Circuit and Voltage Variation: -100% (3 ms), -25% (5 min)
EN 61000-6-4: Emission Standard for Industrial Environments	EN 550011	✓	✓	Conducted Emission: < 30 dB (150 kHz - 30 MHz) ✓ Radiated Emission: < 20 dB (30 MHz - 1 GHz)
Climatic	EN 60068-2-1	✓	✓	Cold: -40 °C
	EN 60068-2-2	✓	✓	Dry Heat: +85 °C
	EN 61163	✓	✓	Reliability Stress Screening: -40 °C to +85 °C, 16 cycles
	EN 60068-2-3	✓	✓	Stationary Humidity: +40 °C, 93% RH, 240 hrs
	EN 60068-2-30	✓	✓	Cyclic Humidity: from +25 °C, 95% RH, to +55 °C, 95% RH, 144 hrs.
Corrosive Environment	EN 60068-2-52	✓	✓	Salt Mist, Cyclic: 5% NaCl; +40 °C, 93% RH, 672 hrs.
Shock and Vibration	EN 60068-2-6	✓	✓	Sinusoidal: 3 mm _{peak} (5 Hz-10 Hz), 2 g _{peak} (10 Hz-500 Hz), 60 min.
	EN 60068-2-64	✓	✓	Random: 1.93 g _{RMS} (5 Hz - 500 Hz), 90 min.
	EN 60068-2-32	✓	✓	Drop: 100 cm, on edge and corners
Robustness to Lubricants and Other Materials	EN 60811-2-1	✓	✓	Ozone Resistance, Hot Set and Mineral Oil Immersion: Impervious to various standard oil, gear oil, hydraulic oil, coolants and yaw lubricants
Degree of Protection	EN 60529	✓	✓	Provided by Enclosure: IP65 minimum

Reliability Data

Calculated (MIL-HDBK-217F): 1.2 x 10⁶ hours

Accelerated Thermal Aging: 1.8 x 10⁶ hours at 60% confidence level (testing ongoing)

11206AC Typical Accuracy & Aging Data, Simulated Adverse Outdoor Conditions

To simulate adverse outdoor conditions, sensors were continuously exposed to the following temperature profile for the duration of the test:

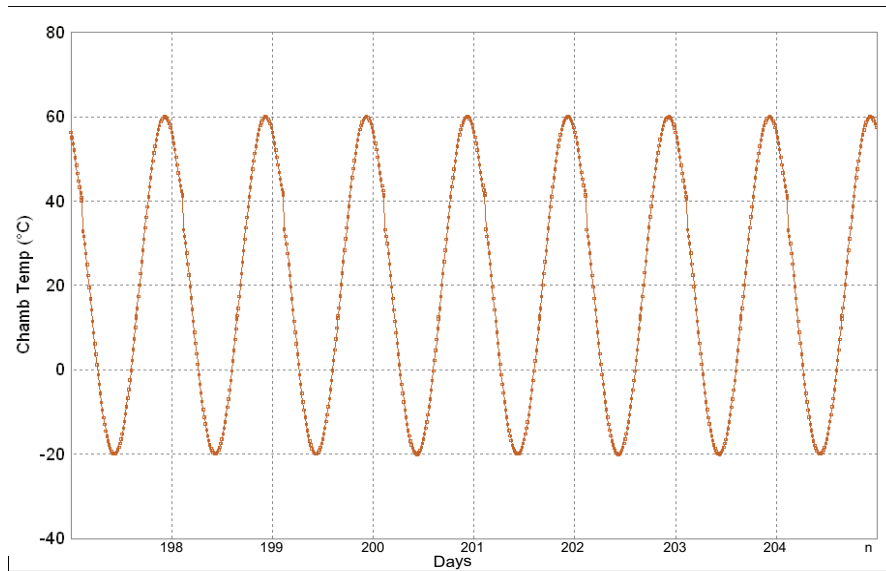

Sinusoidal Cycle of Temperature during Life Test

The graph below shows the absolute value of the sensor measurement error from the ideal transfer function (2.5 V offset, 10 mV/°/s). A sample set of six (6) 180°/s sensors were tested periodically over time (.6 yr.), each one tested each time at 23 rate points and at 25°C, 60°C, and -15°C. The trend line shows the expected drift rate per year.

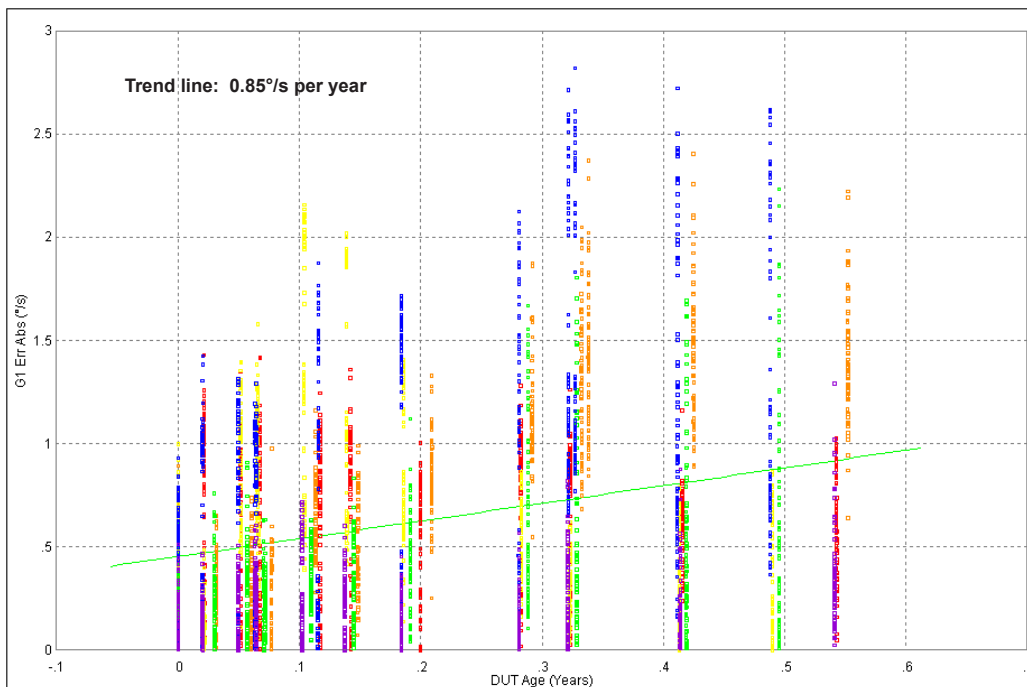

Typical Accuracy over Time with Varying Temperature and Rate

11206AC Typical Accuracy & Aging Data, Under Conditions of Occasional Use

Conditions of occasional use include storage at room temperature and intermittent usage.

The graph below shows the absolute value of the sensor measurement error from the ideal transfer function (2.5 V offset, 10 mV/°/s). A sample set of five (5) 180°/s sensors were tested periodically over time (.7 yr.), each one tested each time at 23 rate points and at 25°C, 60°C, and -15°C. The trend line shows the expected drift rate per year when used occasionally at various temperatures.

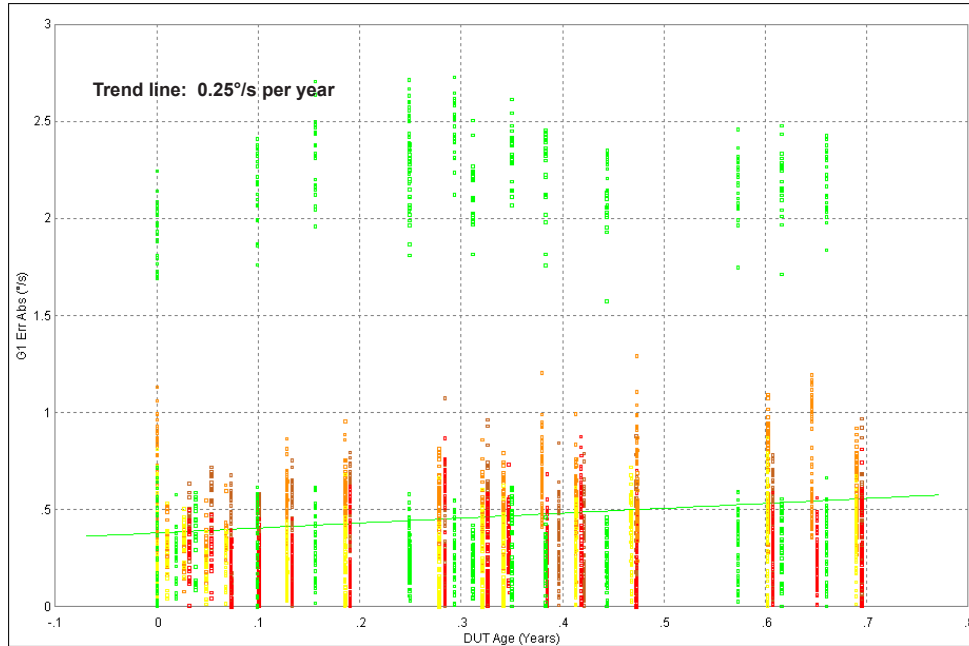

Typical Accuracy over Time with Varying Temperature and Rate

The graph below shows the test results at 25°C for the above sample set. The trend line shows the expected drift rate per year when used occasionally at room temperature.

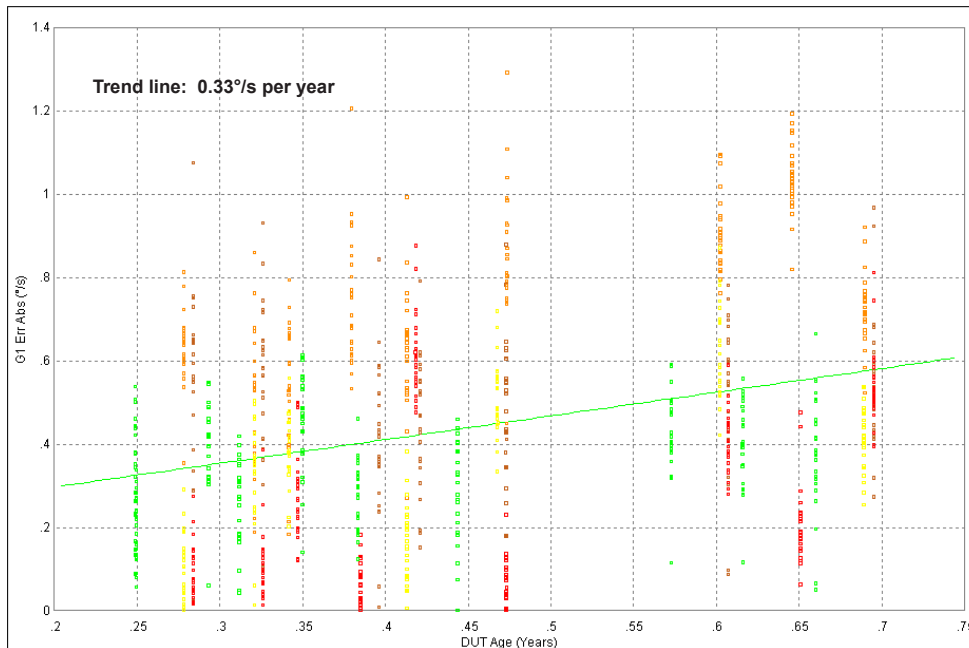

Typical Accuracy over Time with Varying Rate (25°C data only)