



Alta Affidabilità
High Reliability

ACCURATEZZA
 $\leq \pm 0.01\%$
ACCURACY

Risoluzione STANDARD
 ± 50.000 div
STANDARD Resolution

CE RoHS

Stabilità a lungo termine
Long term high stability

USB 2.0

Pressure
Force
Torque
Displacement
in your HANDS...

Star is a professional ergonomic indicator extremely versatile and easy to be used for measurement of FORCE, WEIGHT, PRESSURE (gas), VACUUM, TORQUE and DISPLACEMENT.

It is possible to integrate inside a force sensor (up to max. 5 kN) or a pressure sensor (relative, absolute or differential up to max. 5 bar) while from the external input it is possible to connect strain gauges sensors with output in mV/V such as: load cells, force transducers, pressure transducers, torque and displacement transducers.

Internally the microcontroller processes the signals coming from the sensors through a 24 bit (± 50.000 divisions at 2 mV/V) analog digital converter at a conversion frequency varying from 5 Hz at 4800 Hz by making it suitable for every application that may require both high resolution and high sampling frequencies.

The display of measurements happens through a big graphic backlighted display.

Star is equipped with **USB** interface that allows both the communication in real-time with a PC and the recharge of the internal long-lasting and great reliability battery (Li-Ion).

In addition to the direct reading of the measurements, it is possible to detect PEAKS, block the measurement on the display thanks to the HOLD function and through the internal DATA LOGGER it is possible to record up to 130.000 measurement at programmed intervals or manually through the REC button.

On request, as an **OPTION** it is possible to integrate a WIRELESS interface that allows to communicate with PC, TABLET or PLC in real time.

Typical Applications:

- ✓ Calibration of materials test machines, test benches, pressure tester, pressure switch etc.
- ✓ Quality controls in the production lines, calibration and test laboratories.
- ✓ Compression and tension tests on springs.
- ✓ Tests of frictions, cable terminal tearing, rivets etc.
- ✓ Test of lockup on both packing and protection devices.
- ✓ Test on welding of electronic components.
- ✓ Test of opening and closing of both manual and automatic doors.
- ✓ Test of the handling of both manual and automatic loads.
- ✓ Test on filters, loss and vacuum tests, analysis of pressures variation in the time.
- ✓ Wireless monitoring of hanging loads, mobile weighing.
- ✓ Environmental pressure monitoring. (Barometer)
- ✓ Calibration of: release and direct reading torque keys, screw drivers.
- ✓ Monitoring of cracks through displacement transducers in the building industry.

Available combinations:

Star-F with **internal** sensor to measure **FORCE** and **WEIGHT** in compression and tension in ranges from 10 N (1 kg) up to 5 kN (500 kg)

With **external** sensors ⁽¹⁾ such as load cells or force transducers with standardized ranges up to 5 MN (500 t).



KIT of accessories to perform **COMPRESSION** and **TENSION** tests on materials.

- (A) Hook for tension tests.
- (B) Short threaded extension.
- (C) Long threaded extension.
- (D) Tapered tip for compression testing.
- (E) Toothed tip for compression testing.
- (F) Chisel tip for compression testing.
- (G) Flat tip for compression testing.
- (H) Threaded compass.

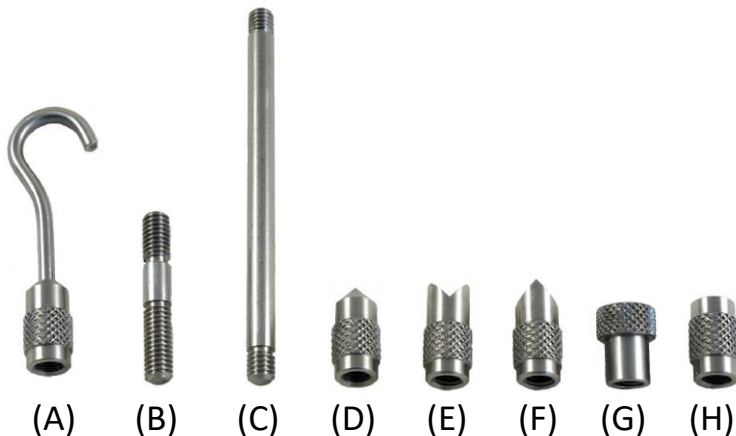

Star-P with **internal** sensor to measure the **VACUUM**, a relative, absolute or differential **PRESSURE** in gas (NO liquids), with ranges from 100 mbar up to 5 bar (1.5 a 70 psi).
 With **external** sensors ⁽¹⁾ such as TP16 or TP1 models to measure higher pressures with standardized ranges up to 2000 bar (29000 psi) suitable for both gas and liquids.



Star with **external**⁽¹⁾ sensors such as TRX, TRS, RT2, uTOR models to measure static or dynamic **TORQUES** with standardized ranges from 1 up to 5000 Nm.
 Possibility of recording continuous **PEAKS** in clockwise and anticlockwise direction at high speed, 4.8 kHz.
 Possibility of recording **1° PEAK** with programmable threshold to test torque keys.

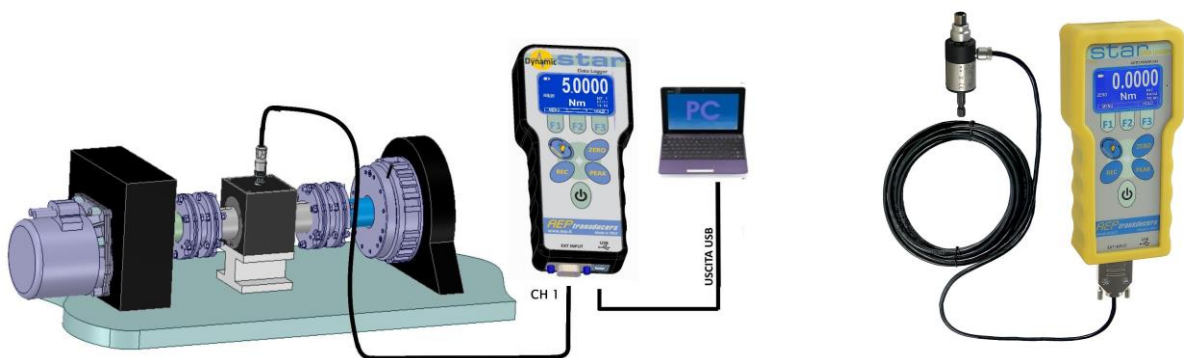

With **external**⁽¹⁾ sensors such as LDT model to measure the **DISPLACEMENT** with standardized ranges from 5 up to 200 mm.



(1) **Star** automatically recognizes a max. number of 7 transducers alternatively connected, by **Auto Configuring** itself with the dedicated parameters (Measurement unit, Filter, Resolution).
 It is possible to connect different sensors to perform measurements of **FORCE**, **WEIGHT**, **PRESSURE**, **TORQUE** and **DISPLACEMENT**.

Main characteristics:

PRESSURE internal sensor ACCURACY: 0.10% F.S. (ON REQUEST 0.05% F.S.)

FORCE internal sensor ACCURACY: 0.05% F.S.

External channel ACCURACY: 0.01% F.S.

REFERENCE temperature 23°C, Service temperature from 0 to +50°C

Temperature effect (10°C): on zero $\leq \pm 0.01\%$, on full scale $\leq \pm 0.01\%$

External INPUT signal 2mV/V (350 or 700 Ω 4 wires system) 5Vdc power supply

Standard resolution ± 50.000 divisions at 2mV/V

HIGH RESOLUTION (128x64 dots) LCD graph **DISPLAY** with 3 levels of backlighting to adapt itself to any conditions of external brightness and with the possibility of rotating the visualization of 180°.

AUTOMATIC recognition of FORCE, WEIGHT, VACUUM, PRESSURE, TORQUE and DISPLACEMENT external transducers (max. 7)

Programmable **MEASUREMENT UNIT:**

FORCE and WEIGHT: kg - g - t - N - daN - kN - MN - lb - klb

PRESSURE: bar-mbar-psi-MPa-kPa-Pa-mH₂O-inH₂O-kg/cm²-mmHg-cmHg-inHg-atm

TORQUE: Nm - Nmm - kgm - kNm - in.lbf - ft.lbf - gcm - kgmm

LENGTH: mm - inch

DIGITAL CALIBRATIONS protected by Password with full scale programming or with the "LINEARIZATION by points" of transducers, for every transducer it is possible to separately calibrate both the positive and the negative field. (Example: Tension and Compression)

DATALOGGER allows to memorize measurements and to keep them in the internal memory even in case of instrument switching off. (max. 130.000 recordings)

Recording can be performed either in **AUTOMATIC mode** by programming an interval of time (from 0.1 sec up to 24 hours) or in **MANUAL** mode through the REC button.

The data can be then showed on the display or downloaded through the powerful software Quick Analyzer for creating graphs, exports in Excel, printing of reports etc.

Programmable **RESOLUTION.**

Digital **FILTER** and **CONVERSIONS per SECOND** (from 5 to 4800) programmable

ZERO function that allows to instantly set to zero the measurement.

HOLD function that allows to temporarily "freeze" the measurement to be able to analyze it.

PEAK function (positive e negative).

Li-Ion internal battery which ensures a 24 hours **AUTONOMY** when backlighting is activated.

In DATALOGGER mode by setting a recording every 5 min. it is possible to perform recordings for approx. 100 hours without recharging the instrument.

AUTO POWER OFF programmable function from 1 up to 99 minutes

CLOCK function (hours, minutes) and internal **CALENDAR** (day, month).

Serial communication through **USB** port, **WIRELESS** data Transmission (ON REQUEST).

Protection grade (EN 60529) **IP40**, painted **ALUMINIUM** case complete with yellow silicone **COVER**, **WEIGHT** ~ 0.7kg

STAR can be manufactured on **REQUEST** equipped with the **WIRELESS** transmission, which allows to transmit the data directly to a PC and to **TABLET** or a **PLC**.

By using **WinWIMOD** software it is possible to create a **NETWORK** with up to 32 units, the net can consist of both **STAR** instruments and sensors interfaced with **WIMOD**.



SOFTWARE APPLICATIONS (to be purchased separately)

To complete the sample measurement system AEP transducers has developed several software applications that interface directly to the instrument and support the operator in the various functions of calibration, testing, analysis, monitoring over time, data storage, transfer of measurements to Microsoft Excel, etc. ...

For this purpose, the software dedicated to calibrations are available 3 different models depending on the size **FORCE**, **PRESSURE** and **TORQUE**.

ForceKAL

Dedicated to the calibration of material testing machines, test benches where a force is generated.

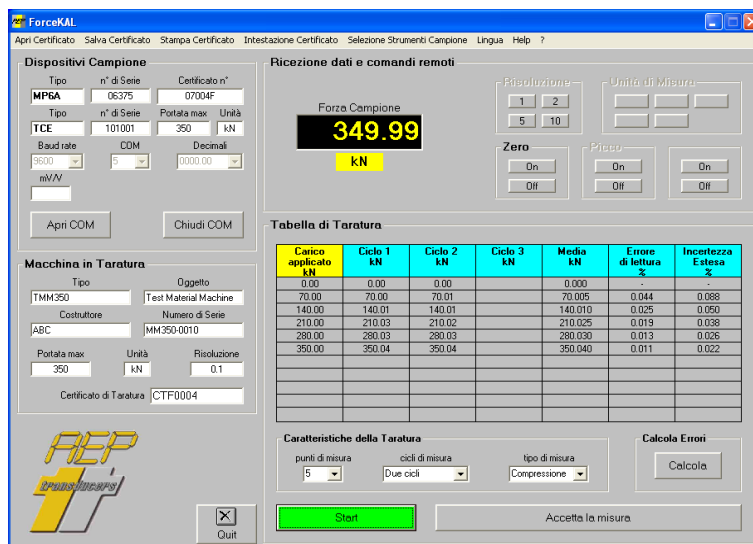

PresKAL

Dedicated to the calibration of pressure gauges such as pressure gauges, pressure transducers, pressure transmitters and pressure switches.

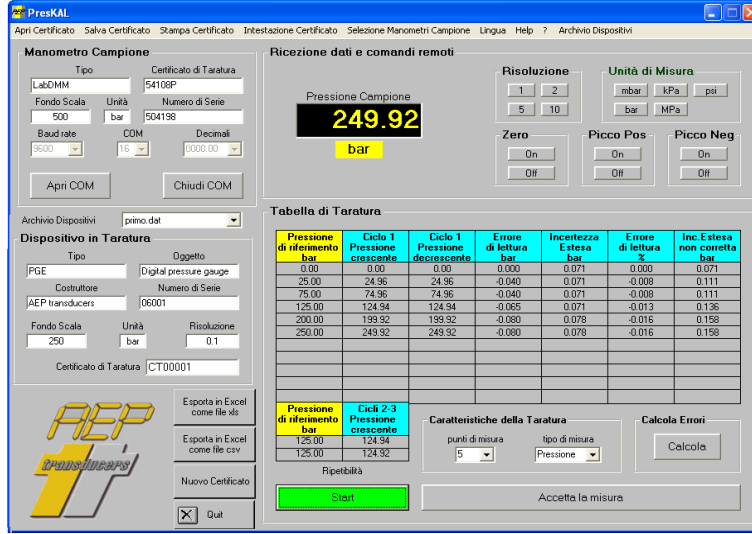

ToqueKAL

Dedicated to the calibration of direct reading or snap-on torque wrenches.

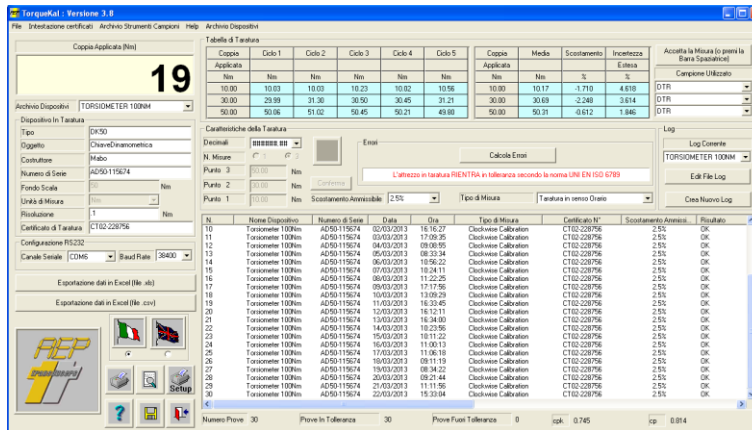

Quick Analyzer

Dedicated to the recording and graphical analysis of up to 16 different instruments for measurements of: Force, Weight, Pressure, Cup and Displacement.

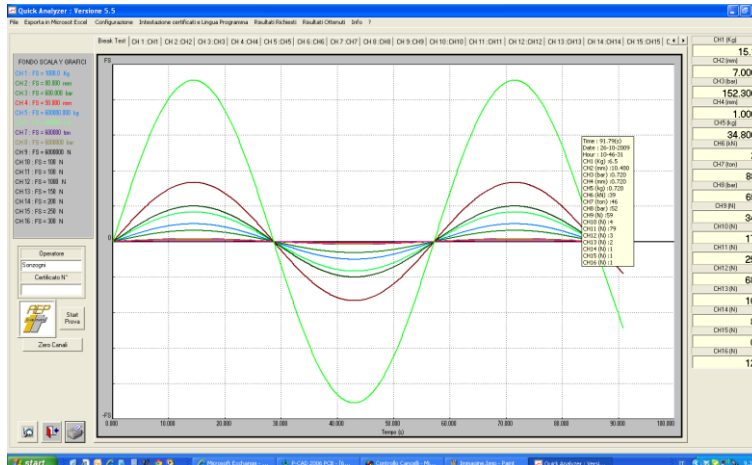

Purchase codes:

STAR	INTERNAL sensor		WIRELESS transmission
ABSOLUTE PRESSURE (Barometer)	500 mbar	500MBARA	W
	1 bar	1BARA	
	2.5 bar	2.5BARA	
	5 bar	5BARA	
RELATIVE PRESSURE	100mbar	100MBAR	
	500 mbar	500MBAR	
	1 bar	1BAR	
	2.5 bar	2.5BAR	
RELATIVE PRESSURE VACUUM	100mbar	100MBARV	
	500 mbar	500MBARV	
	1 bar	1BARV	
	2.5 bar	2.5BARV	
DIFFERENTIAL PRESSURE	100mbar	100MBARD	
	500 mbar	500MBARD	
	1 bar	1BARD	
	2.5 bar	2.5BARD	
FORCE	10 N	10N	
	25 N	25N	
	50 N	50N	
	100 N	100N	
	250 N	250N	
	500 N	500N	
	1000 N	1KN	
	3000 N	3KN	
	5000 N	5KN	

Included accessories:



Travelling case made of ABS



Charger with USB cable

Examples:

STAR	NO INTERNAL sensor • EXTERNAL input max. 7 sensors • USB output
STARW	NO INTERNAL sensor • EXTERNAL input max. 7 sensors • USB output • Wireless transmission
STAR1BAR	INTERNAL sensor 1bar Relative • EXTERNAL input max. 7 sensors • USB output
STAR100NW	INTERNAL sensor 100N • EXTERNAL input max. 7 sensors • USB output • Wireless transmission

PRESSURE internal sensor resolution:

bar		mbar		psi		MPa		kPa		Pa		mH2O	
FS	Ris.	FS	Ris.	FS	Ris.	FS	Ris.	FS	Ris.	FS	Ris.	FS	Ris.
0.1000	0.0001	100.00	0.01	1.4500	0.0001	0.0100	0.0001	10.000	0.001	10000	1	1.0000	0.0001
0.5000	0.0001	500.00	0.10	7.2000	0.0010	0.0500	0.0001	50.000	0.005	50000	5	5.0000	0.0005
1.0000	0.0001	1000.0	0.1	14.500	0.0001	0.1000	0.0001	100.00	0.01	100000	10	10.000	0.001
2.5000	0.0005	2500.0	0.5	36.200	0.005	0.2500	0.0001	250.00	0.05	250000	50	25.500	0.005
5.0000	0.0005	5000.0	0.5	72.500	0.005	0.5000	0.0001	500.00	0.05	500000	50	51.000	0.05

inH2O		Kg/cm2		mmHg		cmHg		inHg		Atm	
FS	Ris.	FS	Ris.	FS	Ris.	FS	Ris.	FS	Ris.	FS	Ris.
40.000	0.005	0.1000	0.0001	75.00	0.01	7.500	0.001	3.0000	0.0002	0.1000	0.0001
200.00	0.02	0.5000	0.0001	375.00	0.05	37.500	0.005	14.500	0.002	0.5000	0.0001
400.00	0.05	1.0000	0.0001	750.0	0.1	75.00	0.01	30.000	0.002	1.0000	0.0001
1000.00	0.10	2.5500	0.0005	1900.0	0.2	190.00	0.02	75.00	0.01	2.5000	0.0002
2000.0	0.2	5.0000	0.0005	3750.0	0.5	375.00	0.05	145.00	0.02	5.0000	0.0005

Limit pressure: 150% Full scale.

FORCE internal sensor resolution:

N		daN		kN		kg		g		lb	
FS	Ris.	FS	Ris.	FS	Ris.	FS	Ris.	FS	Ris.	FS	Ris.
10.000	0.005	1.0000	0.0005	0.0100	0.0005	1.0000	0.0005	1000.0	0.5	2.2000	0.001
25.000	0.005	2.5000	0.0005	0.0250	0.0005	2.5000	0.0005	2500.0	0.5	5.5000	0.001
50.000	0.005	5.0000	0.0005	0.0500	0.0005	5.0000	0.0005	5000.0	0.5	11.000	0.001
100.00	0.05	10.000	0.005	0.1000	0.005	10.000	0.005	10000	5	22.000	0.01
250.00	0.05	25.000	0.005	0.2500	0.005	25.000	0.005	25000	5	55.000	0.01
500.00	0.05	50.000	0.005	0.5000	0.005	50.000	0.005	50000	5	110.00	0.01
1000.0	0.5	100.00	0.05	1.0000	0.0005	100.00	0.05	/	/	220.00	0.1
3000.0	0.5	300.00	0.05	3.0000	0.0005	300.00	0.05	/	/	660.00	0.1
5000.0	0.5	500.00	0.05	5.0000	0.0005	500.00	0.05	/	/	1100.0	0.1

Limit force: 150% Full scale.

Dimensions (mm):

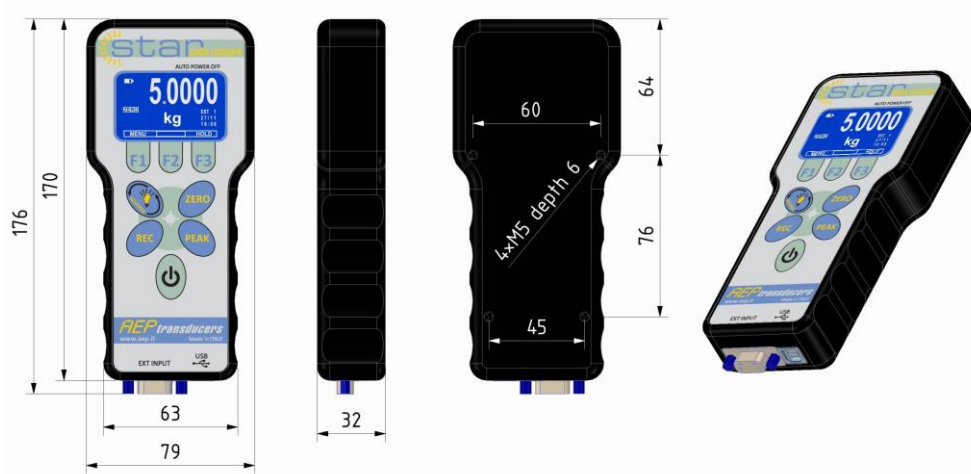

STAR-P

STAR-F



41126 Cognento (MODENA) Italy Via Bottego 33/A Tel: +39-(0)59-346441 Fax: +39-(0)59-346437 E-mail: aep@aep.it

In order to improve the technical performances of the product, the company reserves the right to make any change without notice.